

RAPIDUS

Power Factor
Controller

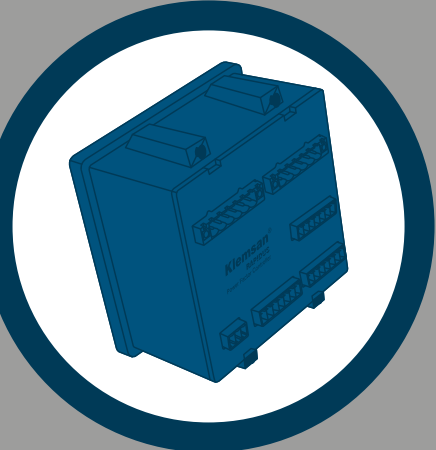
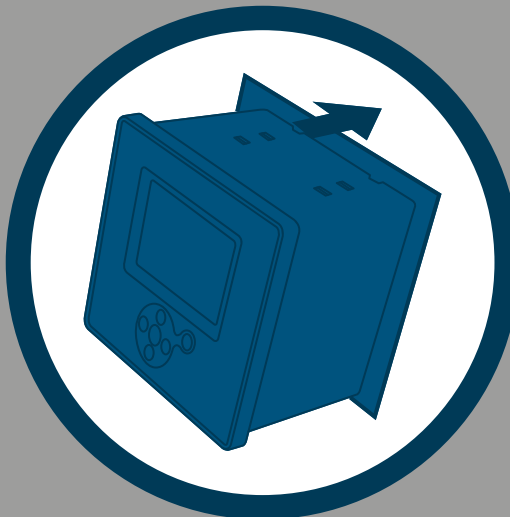

**USER
MANUAL**

Klemsan[®]

TABLE OF CONTENTS

SECTION 1	GENERAL INFORMATION	9
1.1	Symbols	10
1.2	General Warnings	10
1.3	Contents of the Delivery	12
1.4	RAPIDUS Reactive Power Control Relay	12
1.5	RAPIDUS Front Panel	13
1.6	Four-Quadrant Representantion	17
SECTION 2	INSTALLATION	18
2.1	Preparation for Installation	19
2.2	Placing on the panel.....	19
2.3	Connection Diagrams	22
2.4	Dimensions	23
SECTION 3	MENUS	24
3.1	“First Power-on” Settings	25
3.1.1	Dil / Lang. / Язык Setting	25
3.1.2	Date	26
3.1.3	Time Setting	27
3.1.4	CTR.....	27
3.1.5	VTR.....	29
3.1.6	Connection	29
3.1.7	Step Number	30
3.1.8	Start	30
3.2	Startup Screen	31
3.2.1	Settings	31
3.2.1.1	Quick setup Menu	32
3.2.1.1.1	Language Setting	32
3.2.1.1.2	Date Menu	32
3.2.1.1.3	Time Menu	33
3.2.1.1.4	CTR.....	33
3.2.1.1.5	VTR.....	33
3.2.1.1.6	Connection	33
3.2.1.1.7	Step number	33
3.2.1.2	Setup Menu	34
3.2.1.2.1	Network Menu.....	34
3.2.1.2.1.1	CTR Setting	34
3.2.1.2.1.2	VTR Setting	35
3.2.1.2.1.3	Connection	36
3.2.1.2.1.4	Demand period setting	36
3.2.1.2.2	Step Menu.....	36
3.2.1.2.2.1	Ent. Power Menu.....	36
3.2.1.2.2.2	Ent. Type Menu	37
3.2.1.2.2.3	Predefined Menu	37
3.2.1.2.2.3.1	Structure Menu	38

3.2.1.2.2.3.2	Power Menu	38
3.2.1.2.2.3.3	Number Menu	38
3.2.1.2.2.4	Other Menu	39
3.2.1.2.3	Compensation Menu	39
3.2.1.2.3.1	Steps Menu	40
3.2.1.2.3.2	Program Menu	40
3.2.1.2.3.2.1	Rapidus Program	41
3.2.1.2.3.2.2	Ascending Sequential program	42
3.2.1.2.3.2.3	Descending Sequential Mode	43
3.2.1.2.3.2.4	Linear Mode.....	44
3.2.1.2.3.2.5	Circular Mode.....	46
3.2.1.2.3.2.6	Manual program	48
3.2.1.2.3.3	Target 1 Menu.....	49
3.2.1.2.3.4	Target 2 Menu.....	49
3.2.1.2.3.5	Target Low Lim. Menu	50
3.2.1.2.3.6	Target High Lim. Menu	50
3.2.1.2.3.7	Activation Time Menu.....	50
3.2.1.2.3.8	Deactivation Time Menu.....	50
3.2.1.2.3.9	Shift Angle Menu	50
3.2.1.2.3.10	Averaging Time	51
3.2.1.2.3.11	Fixed Steps Menu	51
3.2.1.2.4	Learn Menu.....	52
3.2.1.2.4.1	Learn Conn. Menu	52
3.2.1.2.4.1.1	Learn at start	52
3.2.1.2.4.1.2	Step number	53
3.2.1.2.4.1.3	Retry Timer	54
3.2.1.2.4.1.4	Retry Number	54
3.2.1.2.4.2	Learn Step Menu.....	54
3.2.1.2.4.2.1	Learn at start	55
3.2.1.2.4.3	Aux. Input Menu	55
3.2.1.2.4.4	Off mode.....	55
3.2.1.2.4.5	Night/Day Mode	55
3.2.1.2.4.6	Generator Mode.....	56
3.2.1.2.5	Device Menu	56
3.2.1.2.5.1	Language Setting	56
3.2.1.2.5.2	Contrast Setting	57
3.2.1.2.5.3	Pass. Protection	57
3.2.1.2.5.4	New Password Setting	58
3.2.1.2.5.5	Display On Setting	58
3.2.1.2.5.6	Display On Time Setting	58
3.2.1.2.6	Energy Menu	59
3.2.1.2.6.1	Start of day setting.....	59
3.2.1.2.6.2	Start of month setting	59
3.2.1.2.6.3	kWh Setting	60
3.2.1.2.6.4	kWh E. Setting.....	60
3.2.1.2.6.5	kVArh I. Setting.....	60

3.2.1.2.6.6	kVArh C. Setting	60
3.2.1.2.7	Communication Menu.....	60
3.2.1.2.7.1	Baud Rate Menu.....	60
3.2.1.2.7.2	Slave Id Menu.....	61
3.2.1.2.8	Alarm Menu	61
3.2.1.2.8.1	Energy Alarm Menu	61
3.2.1.2.8.2	VAlarm Menu.....	62
3.2.1.2.8.3	Current Alarm Menu.....	64
3.2.1.2.8.4	P Alarm Menu	64
3.2.1.2.8.5	Q Alarm Menu.....	64
3.2.1.2.8.6	S Alarm Menu.....	64
3.2.1.2.8.7	CosØ Alarm Menu	65
3.2.1.2.8.8	PF Alarm Menu	65
3.2.1.2.8.9	Step Alarm Menu.....	65
3.2.1.2.8.10	F Alarm Menu.....	65
3.2.1.2.8.11	V Harmonics Alarm Menu.....	65
3.2.1.2.8.12	I Harmonics Alarm Menu	66
3.2.1.2.8.13	Temperature Alarm Menu	66
3.2.1.2.9	Clear Menu.....	67
3.2.1.3	Date/Time Menu	69
3.2.1.4	System Info Menu.....	69
3.2.1.5	Password Menu	70
3.2.1.6	Restart	70
3.2.1.7	Default Settings	71
3.2.2	Measure Menu	71
3.2.2.1	Instantaneous Menu	72
3.2.2.2	Energy Menu	73
3.2.2.2.1	Imp. Active Menu (Imported Active Energy Menu)	73
3.2.2.2.2	Exp. Active Menu (Exported Active Energy Menu).....	75
3.2.2.2.3	Ind. Reactive Menu (Inductive Reactive Energy Menu)	75
3.2.2.2.4	Cap. Reactive Menu (Capacitive Reactive Energy Menu).....	75
3.2.2.3	Demand Menu	76
3.2.2.4	Harmonics Menu	77
3.2.2.4.1	Table Menu	77
3.2.2.4.2	Graphic Menu	78
3.2.3	Comp. (Compensation) Menu.....	78
3.2.3.1	Switch Count Menu	79
3.2.3.2	Conn. Time Menu	79
3.2.3.3	DCM (Dynamic Capacitor Monitoring)	80
3.2.3.4	Learn Conn. Menu	80
3.2.3.5	Learned Conn. Menu.....	81
3.2.3.6	Learn Steps Menu.....	81
3.2.4	Alarms Menu	82
3.2.4.1	Phase Menu	83
3.2.4.2	Step Menu.....	84
3.2.4.3	Other Menu	84

3.2.5	Analysis Menu	85
3.2.5.1	Minimum Menu	85
3.2.5.1.1	Hourly Menu.....	85
3.2.5.1.1.1	Phase Menu	86
3.2.5.1.2	Daily Menu	86
3.2.5.1.3	Monthly Menu	86
3.2.5.2	Maximum Menu.....	86
3.2.5.3	Average Menu	86
3.2.5.4	Energy Menu	86
3.2.5.4.2	Daily Menu	87
3.2.5.4.3	Monthly Menu	87

SECTION 4 MODBUS PROTOCOL.....88

4.1	RS485 Wiring Diagram	89
4.2	Computer Connection	89
4.3	Message Format and Data Types of MODBUS-RTU Protocol	89
4.4	Implemented functions for MODBUS-RTU Protocol.....	90
4.5	Data and Setting Parameters for RAPIDUS	90
4.5.1	Measured and Calculated Data	90
4.5.1.1	Readable Data for RAPIDUS 211R-E.....	91
4.5.1.1.1	Alarm Flags(RAPIDUS 211R-E).....	100
4.5.1.2	Readable Data for RAPIDUS 212R-E.....	101
4.5.1.2.1	Alarm Flags(RAPIDUS 212R-E).....	110
4.5.2	RAPIDUS Setting Parameters	111
4.5.2.1	Setting for RAPIDUS 211R-E	112
4.5.2.2	RAPIDUS 212R Ayar Parametreleri	116
4.5.3	ARCHIVE (HISTORY) RECORDS	122
4.5.3.1	Hourly archive data	124
4.5.3.2	Daily archive data	125
4.5.3.3	Monthly archive data	126
4.5.4	Clear(Common for RAPIDUS 211R-E and RAPIDUS 212R-E).....	126

SECTION 5 FACTORY PRESETS 128

SECTION 6 TECHNICAL SPECIFICATIONS..... 133

FIGURES

Fig. 1-1	RAPIDUS 211R-E.....	14
Fig. 1-2	RAPIDUS 212R.....	15
Fig. 1-3	RAPIDUS with 24 RELAYS	16
Fig. 1-4	Step Information Screen for RAPIDUS 232R-E	16
Fig. 1-5	Four-Quadrant Representation	17
Fig. 2-1	Placing RAPIDUS on the Panel.....	19
Fig. 2-2	Securing RAPIDUS	20
Fig. 2-3	Loosening of the Terminal Screws.....	20
Fig. 2-4	Inserting Cable into the Terminal Block	21
Fig. 2-5	Fixing the Cable to the Terminal Block	21
Fig. 2-6	RAPIDUS Connection Diagram (12 Steps)	22
Fig. 2-7	Rapidus Connection Diagram (24 Steps).....	22
Fig. 2-8	Dimensions.....	23
Fig. 3-1	First Operation Settings	25
Fig. 3-2	Dil / Lang./ Язык Setting	25
Fig. 3-3	Date Setting.....	26
Fig. 3-4	Date Setting Example	26
Fig. 3-5	Current Transformer Ratio	27
Fig. 3-6	Entering a Value in Virtual Keyboard	28
Fig. 3-7	Voltage Transformer Ratio.....	29
Fig. 3-8	Step Structure	29
Fig. 3-9	Restart.....	30
Fig. 3-10	Startup Screen when the Connections Are Being Learned.....	30
Fig. 3-11	Startup Screen after the Connections Are Learned	31
Fig. 3-12	Settings Menu.....	31
Fig. 3-13	Quick Setup Menu.....	32
Fig. 3-14	RAPIDUS Prompt for saving	33
Fig. 3-15	Network Menu.....	34
Fig. 3-16	Current Transformer Ratio Setting	34
Fig. 3-17	Voltage Transformer Ratio Setting	35
Fig. 3-18	Demand Period Setting.....	35
Fig. 3-19	Step Menu	36
Fig. 3-20	Ent. Power Menu.....	36
Fig. 3-21	Ent. Type Menu	37
Fig. 3-22	Predefined Menu	37
Fig. 3-23	Other Menu	39
Fig. 3-24	Compensation Menu	39
Fig. 3-25	Program Menu.....	40
Fig. 3-26	RAPIDUS Mode Compensation Steps	41
Fig. 3-27	RAPIDUS Asc. Sequential Mode	42
Fig. 3-28	RAPIDUS Des. Sequential Mode.....	44
Fig. 3-29	RAPIDUS Linear Mode	46
Fig. 3-30	RAPIDUS Circular Mode.....	48
Fig. 3-31	Manual Mode Menu	49
Fig. 3-32	RAPIDUS with 24 RELAYS	49

Fig. 3-33	Step Information Screen for RAPIDUS 232R-E	50
Fig. 3-34	Averaging Time Menu.....	52
Fig. 3-35	Fixed Steps Menu	52
Fig. 3-36	Connection Setup	53
Fig. 3-37	Learning Connections at the Startup.....	54
Fig. 3-38	Waiting Time After Unsuccessful Connection Learning	54
Fig. 3-39	Retry Timer.....	55
Fig. 3-40	Retry Count.....	55
Fig. 3-41	Learn step.....	55
Fig. 3-42	Aux. Input.....	56
Fig. 3-43	Device Menu	57
Fig. 3-44	Contrast Setting	58
Fig. 3-45	Pass. Protection	58
Fig. 3-46	New Password Entry.....	59
Fig. 3-47	Display On Time Setting.....	59
Fig. 3-48	Energy Menu.....	60
Fig. 3-49	Baud Rate Setting.....	61
Fig. 3-50	Slave Id Setting.....	61
Fig. 3-51	Alarm Menu	62
Fig. 3-52	Energy Menu.....	62
Fig. 3-53	V(L-N) Alarm Menu.....	63
Fig. 3-54	Alarm Relay Setting	63
Fig. 3-55	Alarm Time Setting	64
Fig. 3-56	Hysteresis Setting.....	64
Fig. 3-57	Alarm Example	64
Fig. 3-58	V Harmonics Alarm Menu.....	66
Fig. 3-59	THDV High Limit Setting.....	66
Fig. 3-60	V3-V21 Harmonics High Limit Setting	67
Fig. 3-61	No Alarm Time Condition	67
Fig. 3-62	Invalid Limit	68
Fig. 3-63	Clear Menu.....	68
Fig. 3-64	Before Clearing.....	69
Fig. 3-65	After Clearing.....	69
Fig. 3-66	Initial Value Entered After Clearing	69
Fig. 3-67	Date/Time Menu.....	70
Fig. 3-68	System Info	70
Fig. 3-69	Password.....	71
Fig. 3-70	RAPIDUS Restart	71
Fig. 3-71	Default Settings	72
Fig. 3-72	Measure Menu.....	72
Fig. 3-73	Instantaneous Menu	73
Fig. 3-74	Imp. Active Energy Page	74
Fig. 3-75	Hour Start Example.....	74
Fig. 3-76	Day Start Example	75
Fig. 3-77	Month Start Example	75
Fig. 3-78	Demand Menu.....	76
Fig. 3-79	Demand Example.....	77

Fig. 3-80	Current Menu.....	77
Fig. 3-81	Phasor Diagram Menu.....	79
Fig. 3-82	Harmonics Table Menu.....	79
Fig. 3-83	Graphic Menu.....	80
Fig. 3-84	Comp. Menu.....	80
Fig. 3-85	Switch Count.....	81
Fig. 3-86	Conn. Time.....	81
Fig. 3-87	Learn Conn.....	82
Fig. 3-88	Learned Conn. Example-1.....	83
Fig. 3-89	Learned Conn. Example-1.....	83
Fig. 3-90	Learn Steps.....	84
Fig. 3-91	Alarms Menu.....	85
Fig. 3-92	Phase1 Menu.....	85
Fig. 3-93	Step Menu.....	86
Fig. 3-94	Other Menu.....	87
Fig. 3-95	Analysis Menu.....	87
Fig. 3-96	Minimum Menu.....	88
Fig. 3-97	Hourly Menu.....	88
Fig. 3-98	Energy Menu.....	89
Figure 4-1	RS485 Wiring Diagram.....	92
Figure 4-2	RS485 PC Connection.....	92

TABLES

Table 4-1	Message Format.....	89
Table 4-2	int (32 bit) data type.....	90
Table 4-3	Implemented functions for MODBUS RTU Protocol.....	90
Table 4-4	Readable Data(RAPIDUS 211R-E.....	91
Table 4-5	Readable Data(RAPIDUS 212R-E).....	101
Table 4-6	Setting Parameter (Avaliable for RAPIDUS 211R-E).....	112
Table 4-7	String List (Avaliable for RAPIDUS 211R-E).....	116
Table 4-8	Parametreleri (Avaliable for RAPIDUS 212R-E).....	116
Table 4-9	String List (Avaliable for RAPIDUS 212R-E).....	121
Table 4-10	Archive (History) Record Table.....	123
Table 4-11	Clear Address Table.....	127



RAPIDUS

Power Factor
Controller

**SECTION 1
GENERAL
INFORMATION**

SECTION 1 GENERAL INFORMATION

1.1 Symbols

Caution:

This symbol indicates that there is cautionary information where it is used.



Electric Shock Risk:

This symbol indicates that there is dangerous voltage or current.

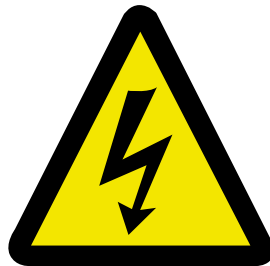

1.2 General Warnings

This user manual is applicable to all RAPIDUS devices which has 144x144cm case and a single current transformer inside

- Voltage measurement input connections:

Overcurrent protection is required for voltage measurement connections V1, V2 and V3: 2 Arms gL fuses (IEC 269) or M type fuses (IEC 127) with rated voltage 300 VAC.

- Compensation relay connections:

Overcurrent protection is required for compensation relay outputs. Fuses are recommended to be inserted at COM connections, namely COM1 (for 1..6 compensation relays) and COM2 (for 7..12 compensation relays). Technical details are as follows: 13 Arms gL fuses (IEC 269) or M type fuses (IEC 127) with rated voltage 300 VAC.

- Alarm relay connections:

Overcurrent protection is required for alarm relay outputs: 3 Arms gL fuses (IEC 269) or M type fuses (IEC 127) with rated voltage 300 VAC.

- It is required to use a circuit breaker in order to easily disconnect RAPIDUS from mains.

Circuit breaker should have the following specifications:

4 poles (one pole for each phase and the fourth pole for the neutral line),

300 VAC or above rated voltage 1 A or above rated current

- Do not use this product for any other purpose than it is designed for.
- When mounted on the wall of the panel enclosure, front side of RAPIDUS will be facing the operator. The remaining of RAPIDUS will be inside an enclosure. This panel enclosure should be a fire enclosure.
- Ensure that energy supply is cut off in the panel or in all relevant systems before attempting to connect the device to mains.
- Installation and connections shall be performed by qualified persons with respect to the instructions on the user's manual.
- Device shall only be activated after all connections are made.
- We advise you to connect a 2 A fuse between the voltage inputs of the device and the mains and supply input and mains.
- We advise you to connect a 1 mm² (AWG17) cable to supply input and measure inputs; and to connect a 2 mm² (AWG14Cu) cable to the current inputs.
- Do not remove RAPIDUS current transformer connections without short circuiting the K-L ends of the current transformer to somewhere else or connecting a load adequate

tely low impedance to the K-L ends. Otherwise, dangerous high voltages may occur on the secondary ends of the current transformer. The same applies to starting of the device.

- Device shall be placed away from damped, wet, vibrating and dusty environments.
- Use a dry cloth to clean the device or remove the dust on it. Do not use alcohol, thinner or an abrasive agent.
- Do not open the inside of the device. There are no user-maintainable components inside.

1.3 Contents of the Delivery

When the RAPIDUS is delivered to you, check that:

- the packing of RAPIDUS is in good condition
- the product is not damaged during transport
- name of the product and order number is correct.

RAPIDUS Order No:	Short code	Description
606011	RAPIDUS 211R	Rapidus 12 relays
606014	RAPIDUS 212R	Rapidus 24 relays

Contents of the RAPIDUS packing is listed below.

- 1 RAPIDUS
- 1 CD-ROM (User's Manual)
- 4 panel tightening tools
- 1 pc of 4-pin female terminal for alarm outputs (NO, C/out2, C/out1, NO)
- 1 pc of 6-pin female terminal for current inputs (I1, k1, I2, k2, I3, k3)
- 1 pc of 4-pin female terminal for voltage input (V1, V2, V3, N)
- 2 pcs of 7-pin female terminal for step outputs (Com1, Com2, K1...K12)
- 1 pc of RS485 3-pin female terminal (D+, GND, D-)
- 1 pc of 2-pin female terminal for generator input (GenA, GenB)

NOTE: 4 pcs of 7-pin female terminal for step outputs (Com1, Com2, Com3, Com4, K1...K24) for RAPIDUS 212R

1.4 RAPIDUS Reactive Power Control Relay

RAPIDUS is a multi-function reactive power control relay. It measures active, reactive and total powers of the system that it is connected. As a result of these measurements, it activates capacitor and shunt reactors in the compensation panel. Thus, it compensates the system reactive power bidirectionally.

RAPIDUS counters record “imported active”, “exported active”, “inductive reactive” and “capacitive reactive” energy values.

All user actions can be performed easily using the 160x240 graphic LCD display and 6 keys on the front panel.

RAPIDUS has an isolated RS485 port.

It also has 2 alarm relay outputs.

RAPIDUS measures/calculates

- Current, voltage and frequency
- Active, reactive and apparent power
- Current and voltage harmonics up to 51st harmonics
- THDV, THDI
- Power factor, $\cos\phi$

values for each phase.

RAPIDUS has features such as:

- Learning connection methods
- Learning step powers and types
- Recording switching numbers and duty ratios for each step
- Compensation possibility with 6 different programs
- Determination of whether the activated step is faulty and dynamic step monitoring
- For active, reactive (inductive and capacitive) energy, values of index, hourly, previous hour, previous day, monthly and previous month
- Compensation in 12/24 steps
- Current and voltage harmonics measurement up to 51st harmonics
- Testing possibility for relays and steps
- Automatic calculation of C/k ratio

Also, RAPIDUS has the following features:

- Setting an alarm for various measurement parameters
- Provision of counter monitoring by assigning initial counter values
- Prevention of unauthorized usage with 4 digit password input
- Battery supported real time timer and memories

1.5 RAPIDUS Front Panel

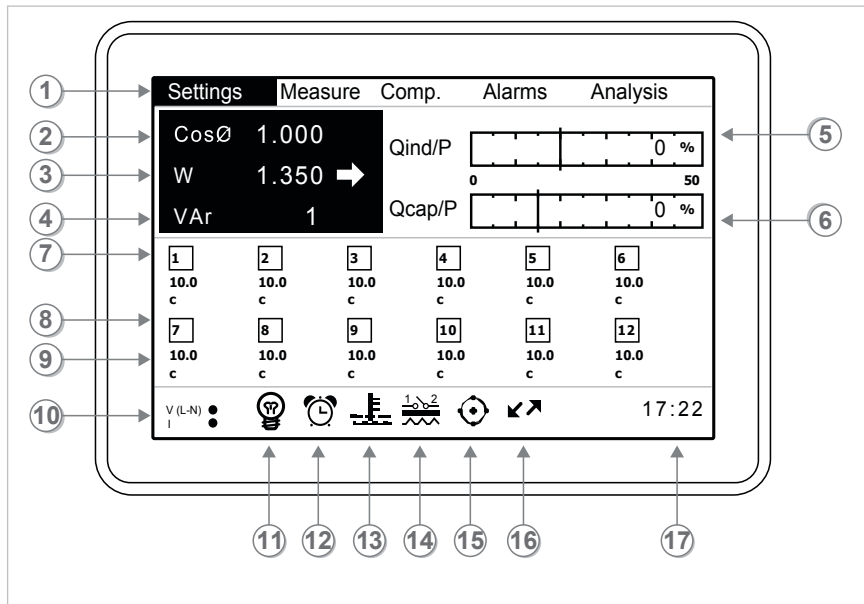

Fig. 1-1 RAPIDUS 211R-E

- 1 Menus
- 2 SystemcosØ
- 3 Total Active PowerPowervalue of the system
- 4 Total Reactive Powervalue of the system
- 5 Monthly average inductive ratio
- 6 Monthly average capacitive ratio
- 7 Number of steps
- 8 Step power
- 9 Step type
- 10 Presence/absence of currents and voltages
- 11 Selected compensation mode
 - 💡 => Rapidus mode (Smart mode)
 - 📈 => Asc. sequential mode
 - 📉 => Des. sequential mode
 - 📊 => Lineer mode
 - 🔄 => Circular mode
 - 👉 => Manual mode
 - ⚠️ => Caution Symbol (It is displayed when learning connections are failed)
 - 🕒 => Hourglass (It is displayed when connections or step powers are being learned)
- 12 Alarm status symbol (displayed when alarm occurred in system)
- 13 Temperature alarm status symbol (displayed when an alarm occurred in the system)
- 14 Alarm relay symbol (This symbol is displayed if 1st and/or 2nd alarm relay is assigned to an alarm and an alarm is present in the system. "1" indicates 1st alarm relay, and "2" indicates 2nd alarm relay on the symbol)
- 15 Indicates that DCM is active
- 16 RS485 communication symbol
- 17 System clock

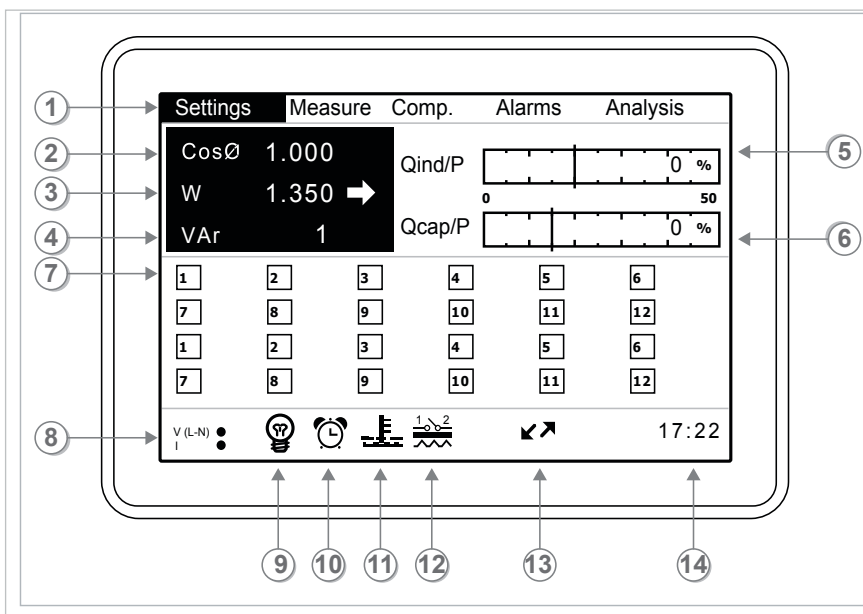

Fig. 1-2 RAPIDUS 212 R

- 1 Menu
 - 2 SystemcosØ
 - 3 Total Active Power value of the system
 - 4 Total Reactive Power value of the system
 - 5 Monthly average inductive ratio
 - 6 Monthly average capacitive ratio
 - 7 Number of steps
 - 8 Presence/absence of currents and voltages
 - 9 Selected compensation mode
- 💡 => Rapidus mode (Smart mode)
 - 📈 => Asc. sequential mode
 - 📉 => Des. sequential mode
 - 📊 => Linear mode
 - 🔄 => Circular mode
 - 👉 => Manual mode
 - ⚠ => Caution Symbol (It is displayed when learning connections are failed)
 - 🕒 => Hourglass (It is displayed when connections or step powers are being learned)
- 10 Alarm status symbol (displayed when alarm occurred in system)
 - 11 Temperature alarm status symbol (displayed when an alarm occurred in the system)
 - 12 Alarm relay symbol (This symbol is displayed if 1st and/or 2nd alarm relay is assigned to an alarm and an alarm is present in the system. "1" indicates 1st alarm relay, and "2" indicates 2nd alarm relay on the symbol)
 - 13 RS485 communication symbol
 - 14 System clock
- If operator press down key, below screen is shown.

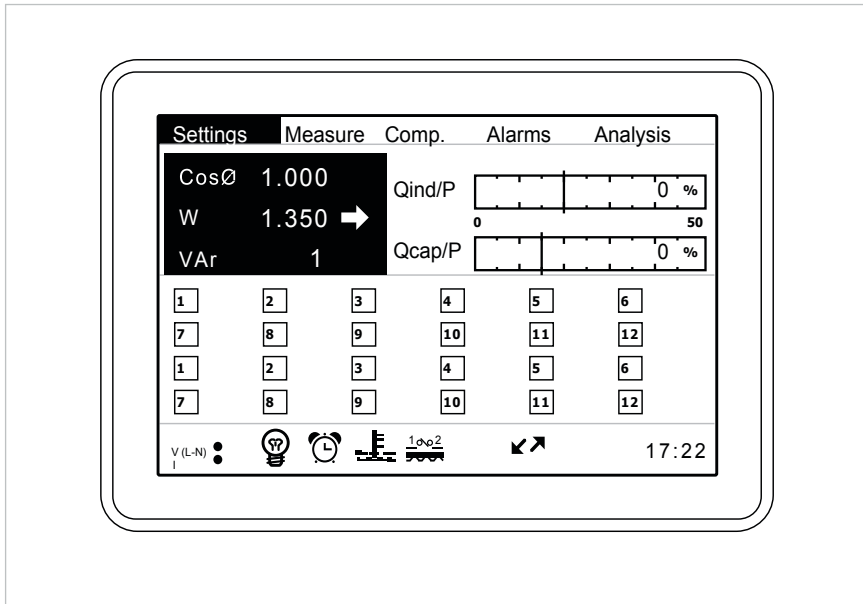

Fig. 1-3 Selected Step for RAPIDUS 212R

Operator can scroll inside steps by pressing right and left keys. When OK key is pressed below screen is shown.

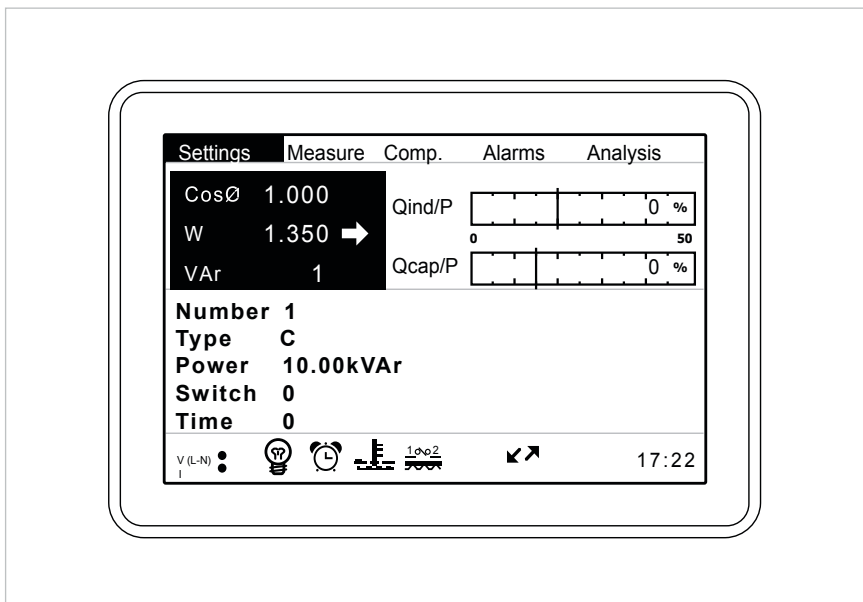

Fig. 1-4 Step Information Screen for RAPIDUS 212R



1.6 Four-Quadrant Representation

The angle(θ) between voltage and current provides us information about the direction of energy flow. A positive sign for active/reactive power indicates that active/reactive power is consumed.

And also a negative sign for active/reactive power indicates that active/reactive power is generated.

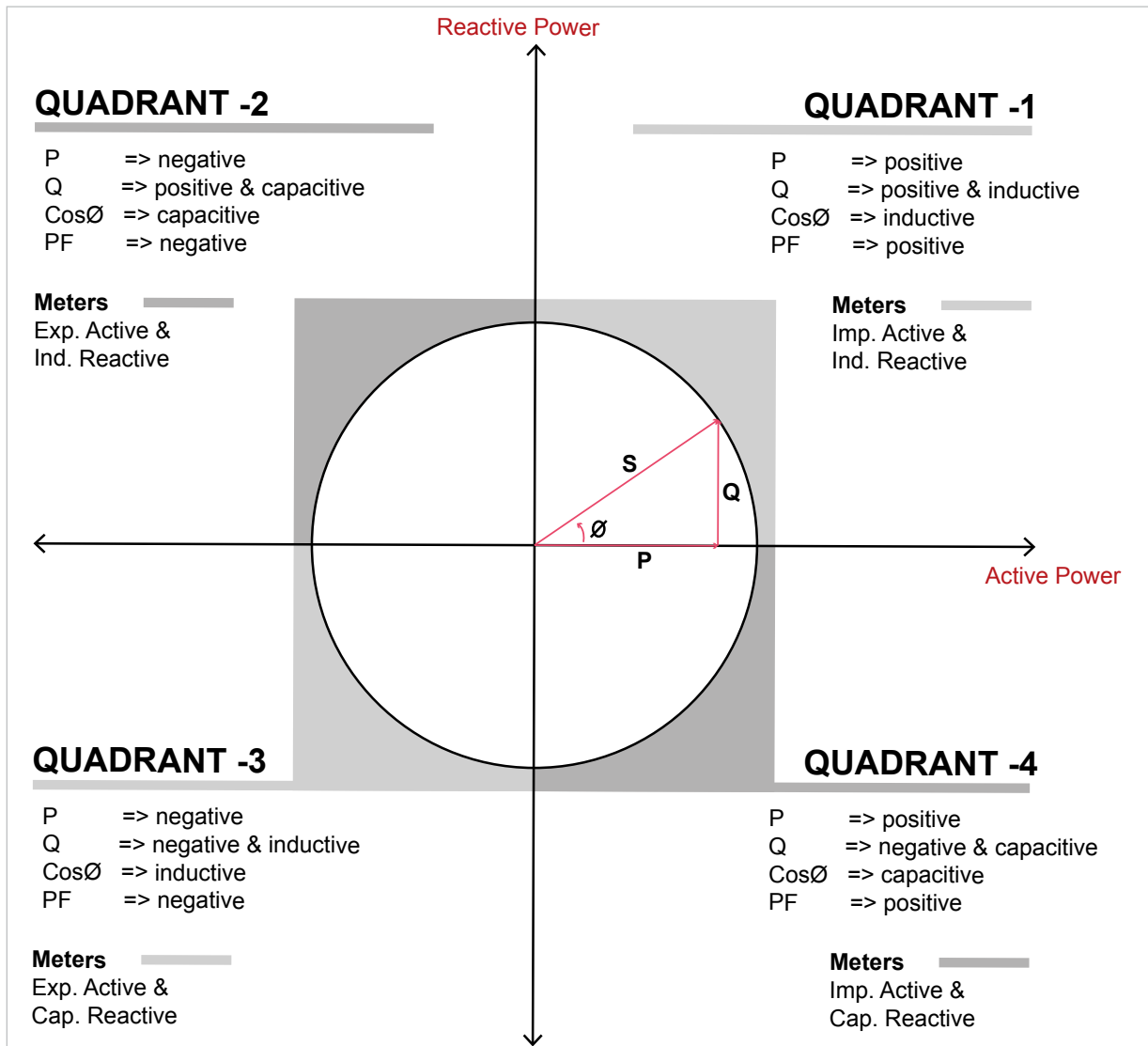

Fig. 1-5 Four-Quadrant Representation

NOTE: If the signs of active and reactive power are examined, it can be defined the quadrant that Rapidus measures.

e.g.

- P= +10kWh, Q= +5kVAr => Quadrant-1
- P= -10kWh, Q= +5kVAr => Quadrant-2
- P= -10kWh, Q= -5kVAr => Quadrant-3
- P= +10kWh, Q= -5kVAr => Quadrant-4



RAPIDUS

Power Factor
Controller

SECTION 2
INSTALLATION

SECTION 2 INSTALLATION

This section contains information on the installation, cable connections and connection methods of RAPIDUS.

2.1 Preparation for Installation

RAPIDUS that you have purchased may not include all hardware options specified in the installation manual. This is not issue for the electrical installation.



Installation and connections of RAPIDUS shall be performed by qualified persons with respect to the instructions on the user's manual.



Do not operate the device before making the connections correctly.

2.2 Placing on the panel

RAPIDUS is placed vertically on the empty compartment on the panel.

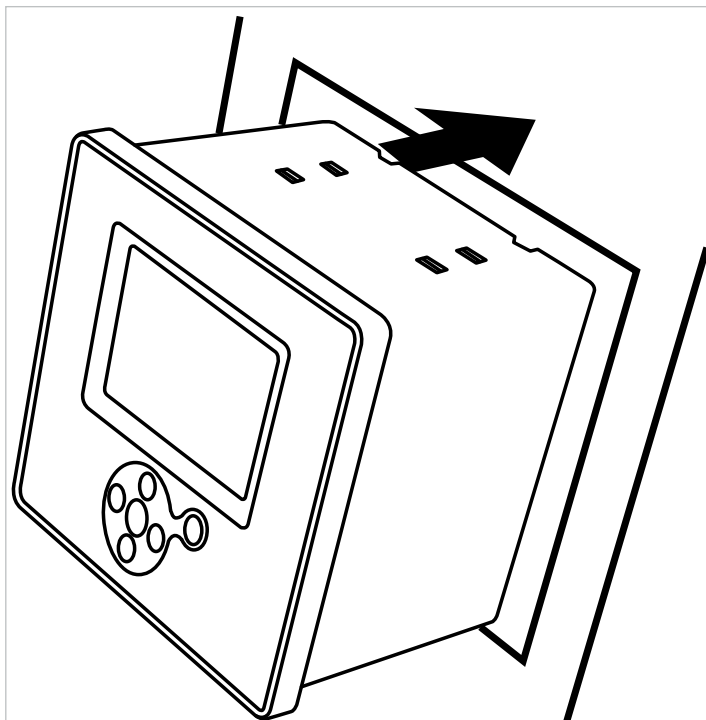

Fig. 2-1 Placing RAPIDUS on the Panel

After placing RAPIDUS on the panel tightening tool is installed and then secured by tightening its screw.

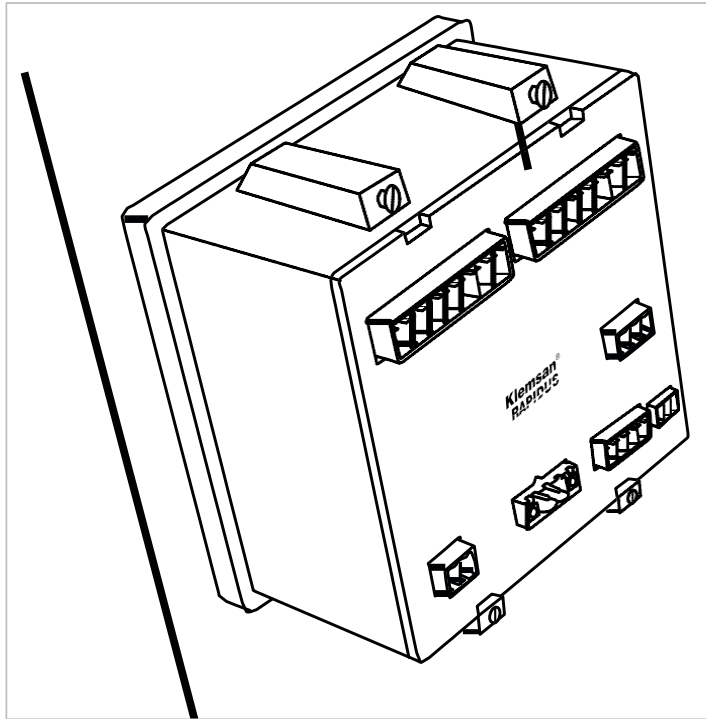

Fig. 2-2 Securing RAPIDUS

RAPIDUS has female terminals with 2.5mm² and 1.5mm² screws. Female terminal is removed on its housing on RAPIDUS (removed from the fixed male terminal). Screws on the female terminal are loosened.

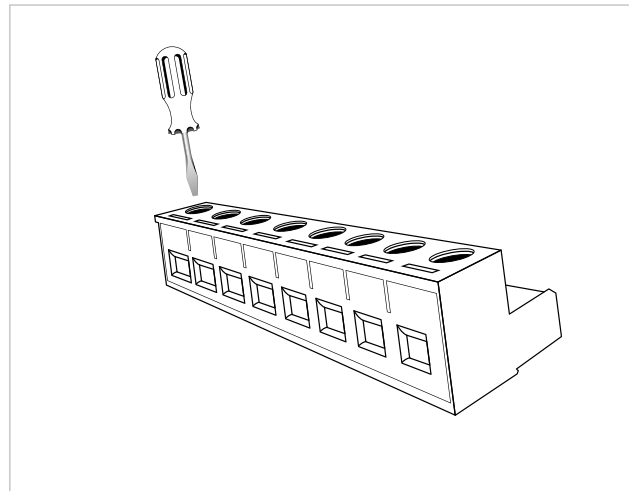

Fig. 2-3 Loosening of the Terminal Screws



Make sure that the power is cut off before connecting voltage and current ends to RAPIDUS.



Do not remove RAPIDUS current transformer connections without short circuiting the K-L ends of the current transformer to somewhere else. Otherwise, dangerous high voltages may occur on the secondary ends of the current transformer. The same applies to starting of the device.

Cable is placed in the relevant connection hole.

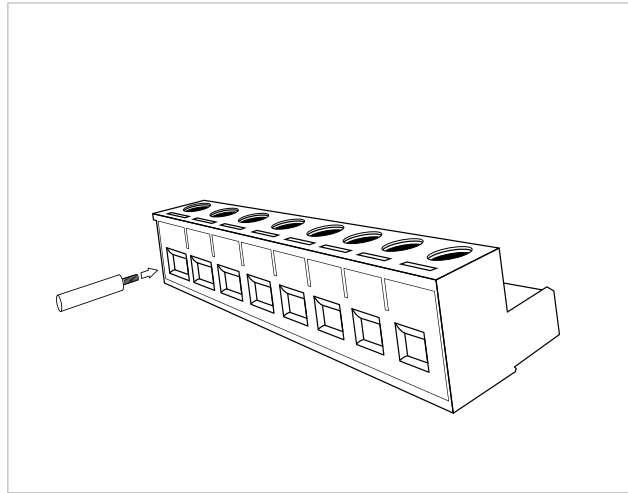

Fig. 2-4 Inserting Cable into the Terminal Block

After inserting the cable, screws are tightened to fix the cable.

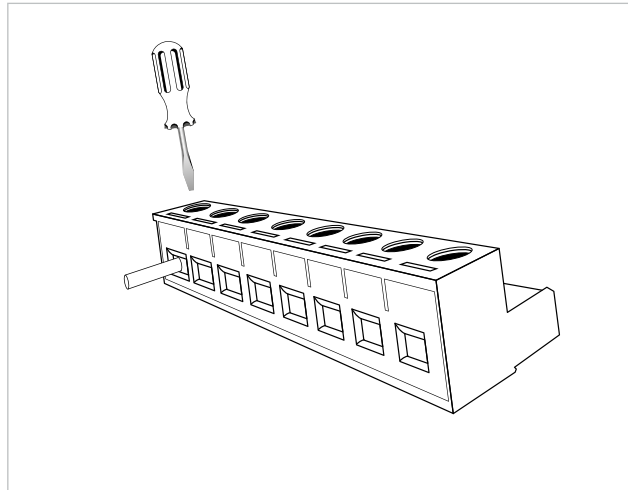

Fig. 2-5 Fixing the Cable to the Terminal Block

Terminal is placed on its housing on RAPIDUS.



Consider this warning if RAPIDUS is used with current transformers. Correct operating threshold values of transformers vary as per the type and size of the current transformers used. Please check that the measured current value is higher than the current threshold specified in the user's manual of current transformer."

2.3 Connection Diagrams

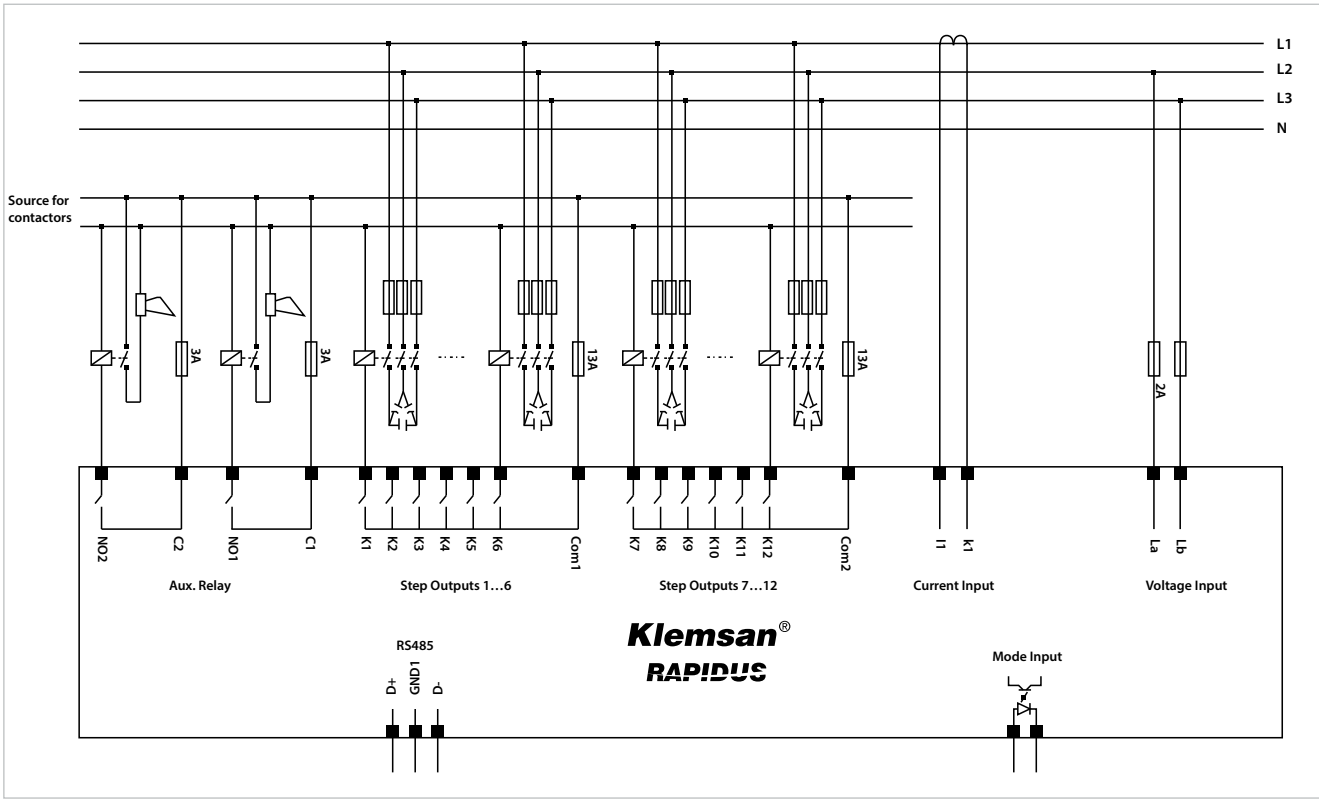

Fig. 2-6 RAPIDUS Connection Diagram (12 Steps)

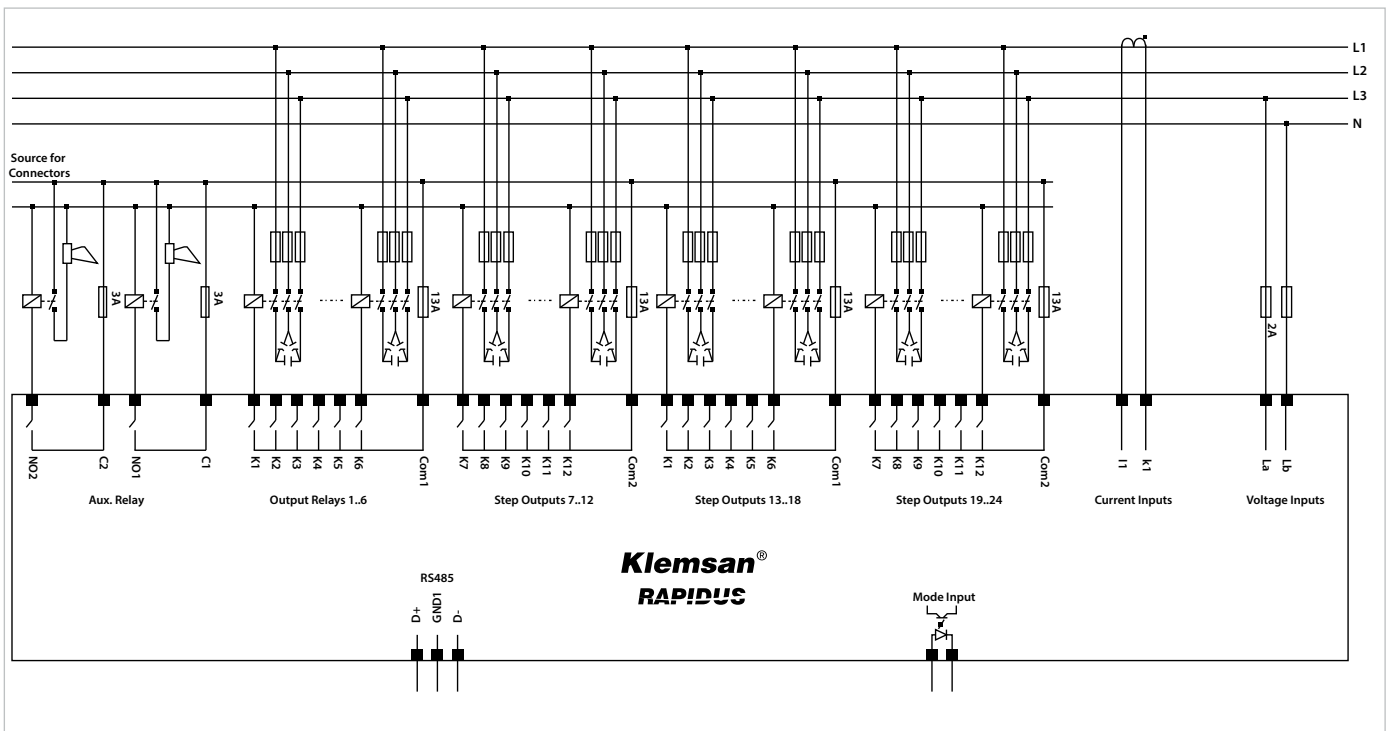

Fig. 2-7 Rapidus Connection Diagram (24 Steps)

2.4 Dimensions

Dimensions are given in millimeters.

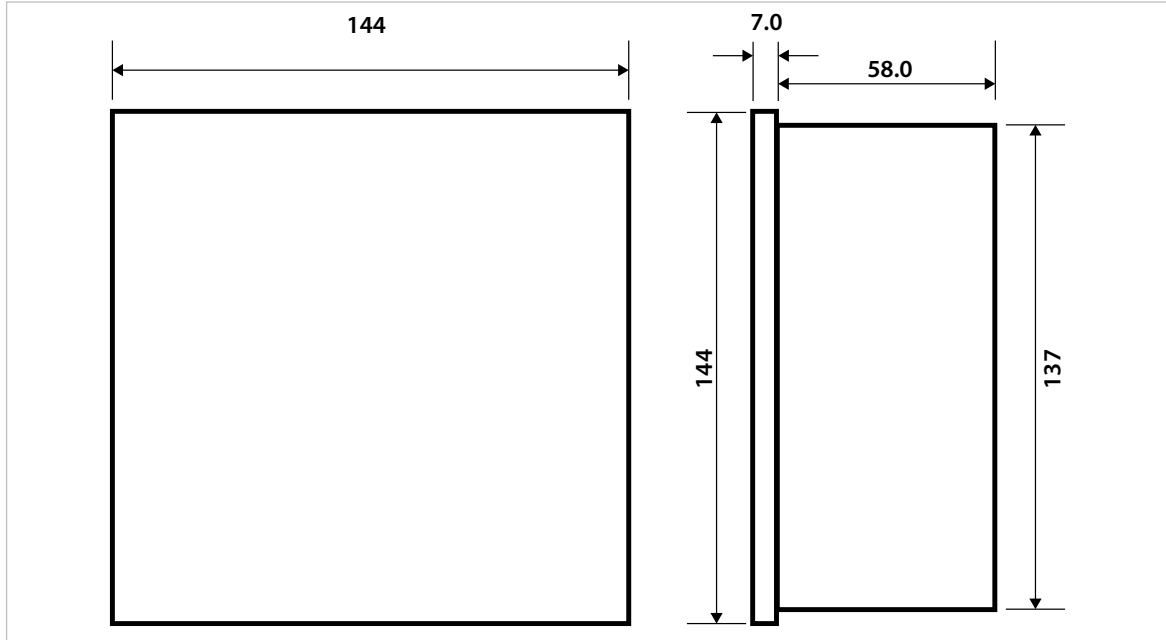

Fig. 2-8 Dimensions



RAPIDUS

Power Factor
Controller

**SECTION 3
MENUS**

SECTION 3 MENUS

3.1 "First Power-on" Settings

The following page is displayed when RAPIDUS is energized for the "first time" after it is released from the factory

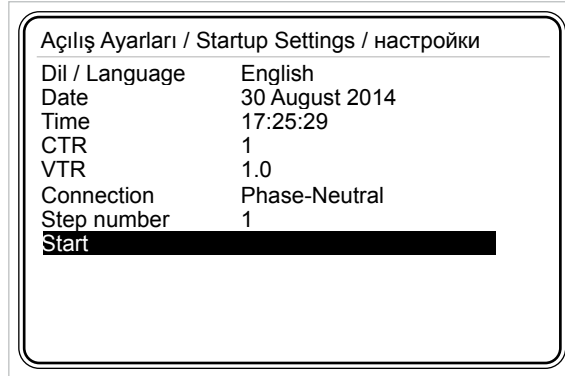

Fig. 3-1 First Operation Settings

3.1.1 Dil / Lang. / Язык Setting

When OK key is pressed on this tab, "Turkce", "English" and "Русский" options appear on the screen as seen below. Operator can scroll inside the options by pressing up and down keys and then should press "OK" to select the desired option. If language is selected as English, other tabs within this page will also be in English.

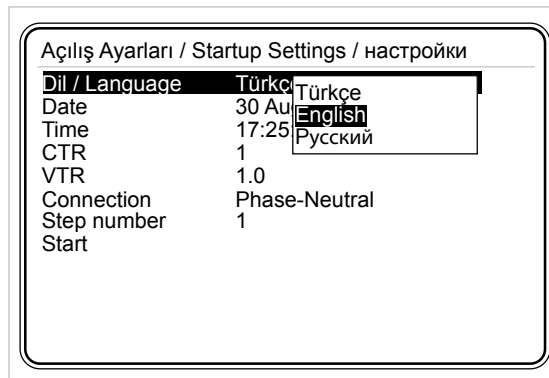

Fig. 3-2 Dil / Lang./ Язык Setting

3.1.2 Date Setting

In order to change the date, operator should press OK key, when “Date” tab is highlighted. Press right and left to move between day, month and year entries. Press up and down keys to change the values. Press OK key to complete date setting.

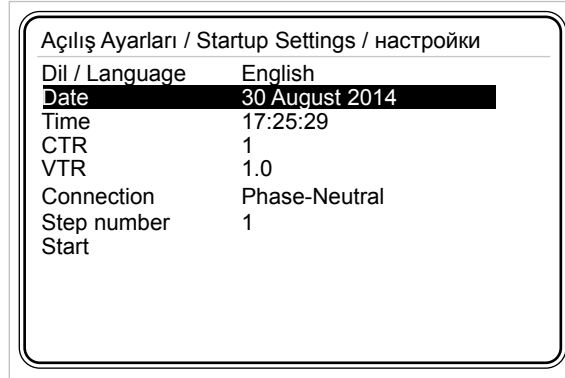

Fig. 3-3 Date Setting

Example: To select “August 30th, 2014”:

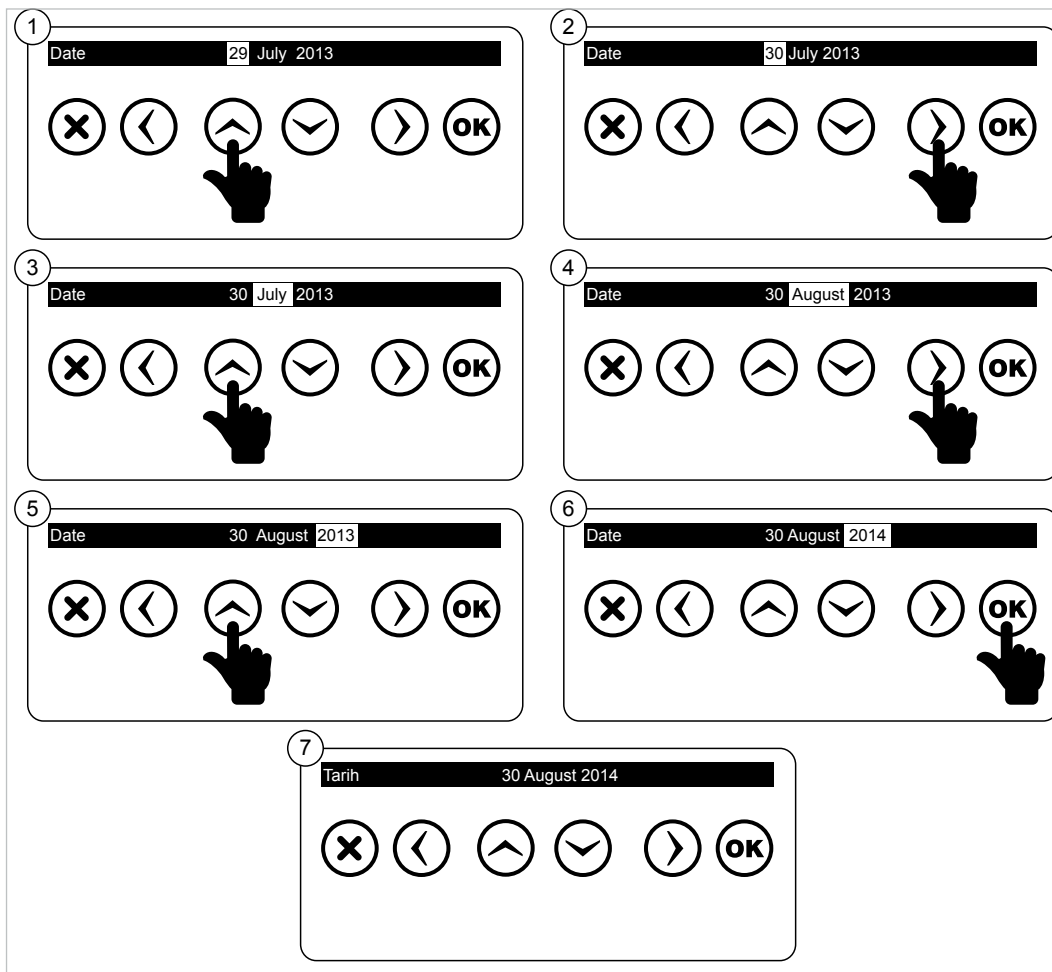

Fig. 3-4 Date Setting Example

3.1.3 Time Setting

Time setting of RAPIDUS is performed here. It is set as described on [3.1.2 Date](#) menu.

3.1.4 CTR

In this tab, current transformer ratio is entered. The current transformer ratio can be adjusted between 1-5000. When this tab is highlighted; if the operator presses OK key, RAPIDUS Virtual Keyboard will appear on the screen.

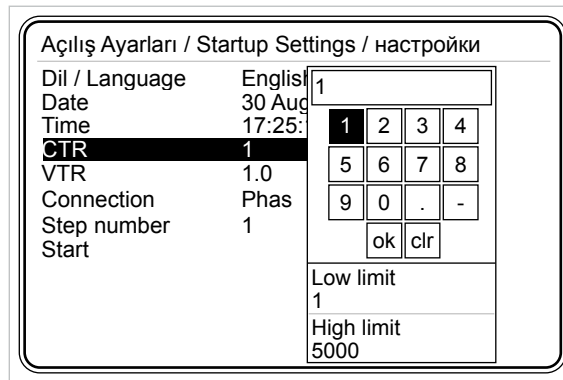

Fig. 3-5 Current Transformer Ratio

Use arrow keys (left, right, up and down) of RAPIDUS to navigate inside the virtual keyboard. In order to enter any number in the virtual keyboard as a value, when that number is highlighted, press OK key of RAPIDUS. When 'ok' box of virtual keyboard is highlighted, press

'OK' key of RAPIDUS to complete current transformer setting. In case an incorrect digit is entered, scroll inside the virtual keyboard to select **clr** box. Then pres 'OK' key of RAPIDUS to erase erroneous entered digit(s).



Current transformer ratio should be entered correctly. Otherwise, RAPIDUS CANNOT accurately compensate electrical system.

Example:

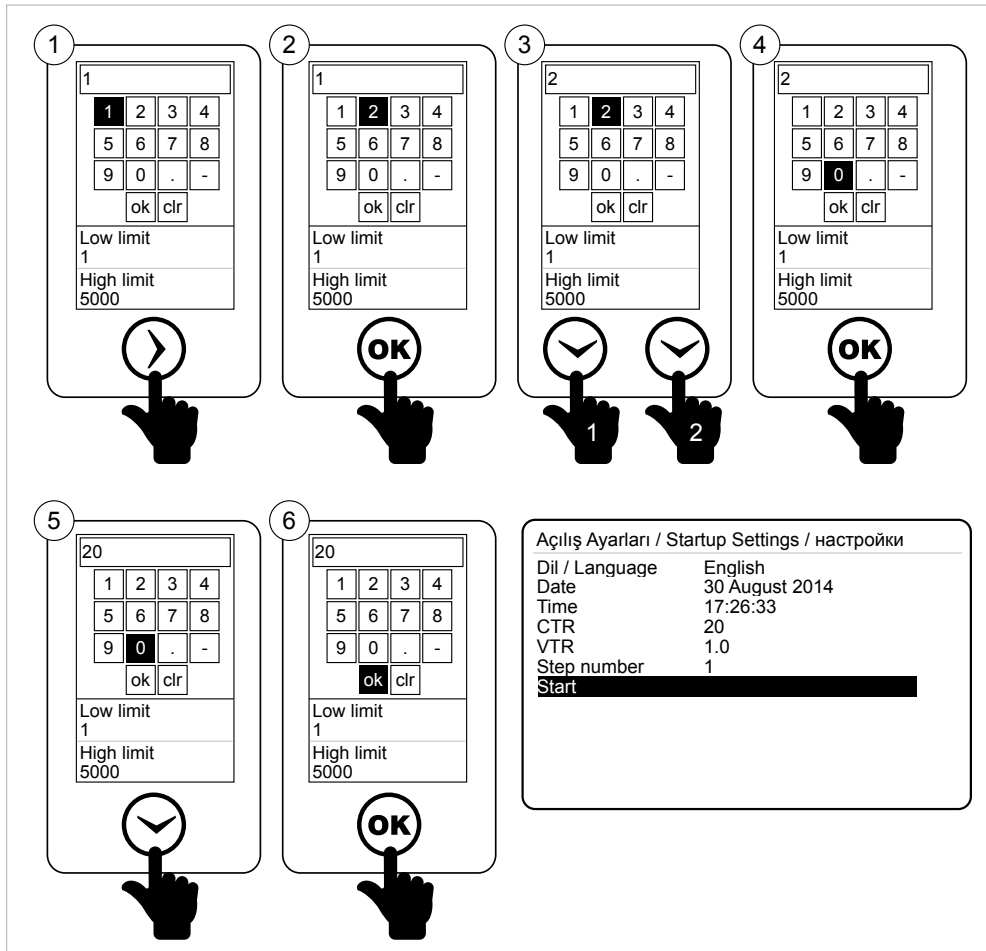

Fig. 3-6 Entering a Value in Virtual Keyboard



To enter a decimal value, enter the integer part of the decimal number first. Then scroll inside virtual keyboard till box is highlighted. Press OK key of RAPIDUS to insert the decimal point. Following the point enter the decimal part of the desired value.



To enter a negative value, enter the number, inside the virtual keyboard point to the negative sign box and press OK.

3.1.5 VTR

This is the settings tab for entering the voltage transformer ratio. Voltage transformer ratio may be selected between 1 and 5000. (For the usage of RAPIDUS Virtual Keyboard, See 3.1.4 Example). If you will enter a number with a decimal place for voltage transformer ratio, select the box on the Virtual Keyboard with arrow keys and press OK.

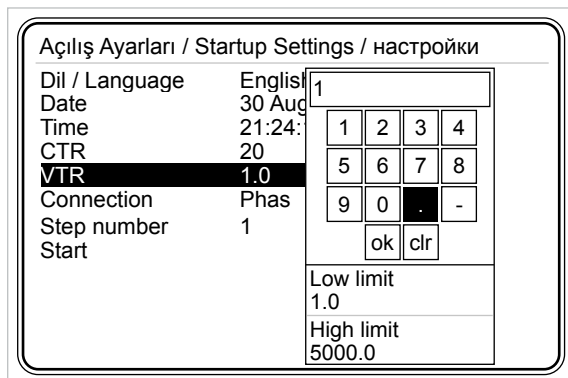

Fig. 3-7 Voltage Transformer Ratio



Voltage transformer ratio should be entered correctly. Otherwise, RAPIDUS CANNOT accurately compensate electrical system.

3.1.6 Connection

This menu contains information about how to connect RAPIDUS to the panel/electrical network. There are 2 connection types:

- phase – phase
- phase – neutral

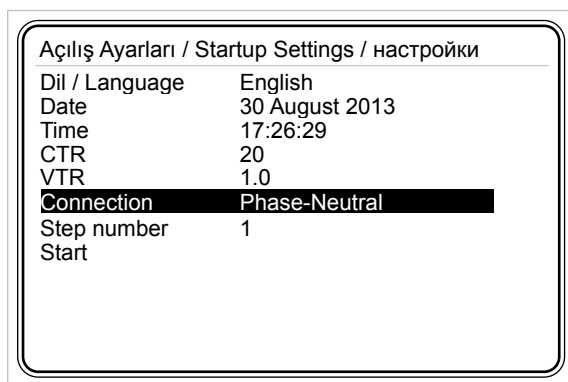

Fig. 3-8 Connection

3.1.7 Step number

You shall enter the 3-phase capacitor step number required for learning the connections from this menu

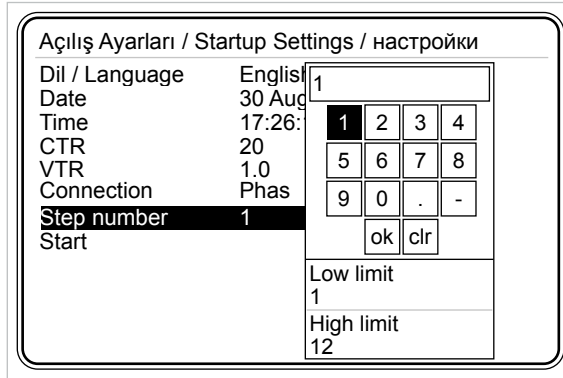

Fig. 3-9 Step Number

3.1.8 Start

RAPIDUS shall be restarted when you press OK when the Restart tab is highlighted.

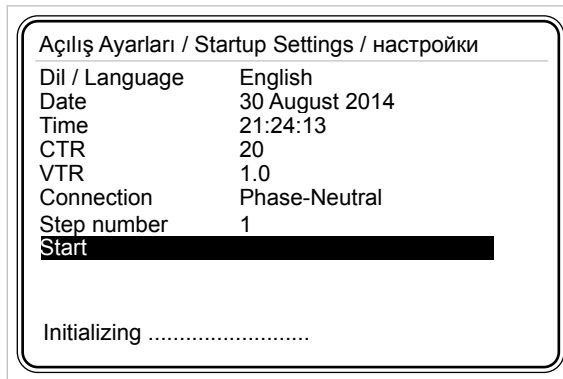

Fig. 3-10 Restart



RAPIDUS “first power-on” settings page only appears when RAPIDUS is powered up for the first time after factory production. Following this first initialization, all the required settings (including “first power-on” page settings) can be accomplished via Settings menu.

3.2 Startup Screen

Following screen page shall be displayed after RAPIDUS is started. When Rapidus powered on, firstly connection then steps powers are learned.

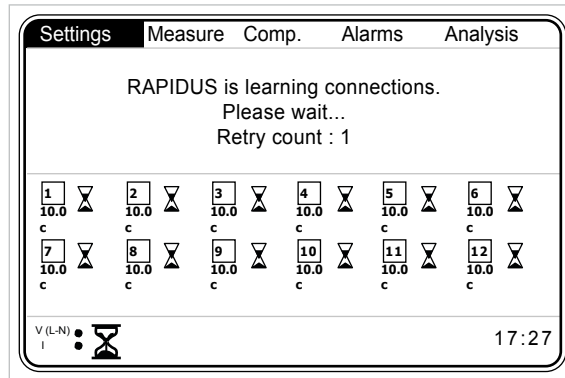

Fig. 3-11 Startup Screen when connection is learned

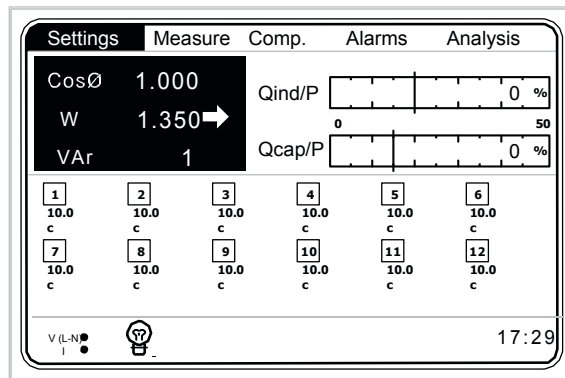

Fig. 3-12 Startup Screen after learning

Multi selection menus are displayed on the upper part of the screen.

Average $\cos\phi$, total active power and total reactive power values of the measured phase on the upper left corner.

Upper right corner displays capacitive and inductive ratios.

Status of the phases and compensation mode are displayed on the lower left corner, and system clock is displayed on the lower right corner.

User may navigate on the menus on the upper side of the screen using left and right arrow keys, and access the contents of the menus by pressing OK.

3.2.1 Settings

RAPIDUS settings are made from this menu. If you press OK when the settings tab is highlighted, sub-menus shall be displayed as shown in Fig. 3-13. Sub-menus below are available under the settings tab.

- Quick setup
- Setup
- Date/Time
- System info
- Password
- Restart
- Default Settings

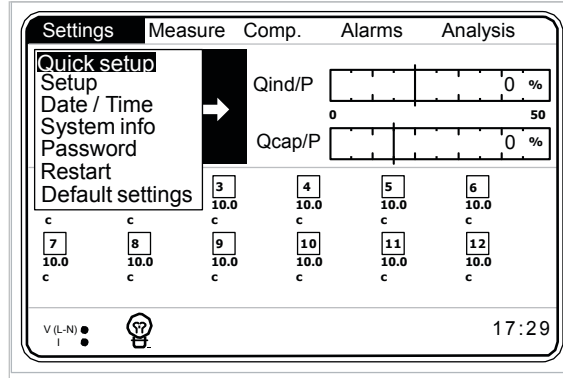

Fig. 3-13 Settings Menu

3.2.1.1 Quick setup Menu

Sub-menus below are available under the quick setup tab:

- Dil / Lang. / Язык
- Date
- Time
- CTR
- VTR
- Connection
- Step number

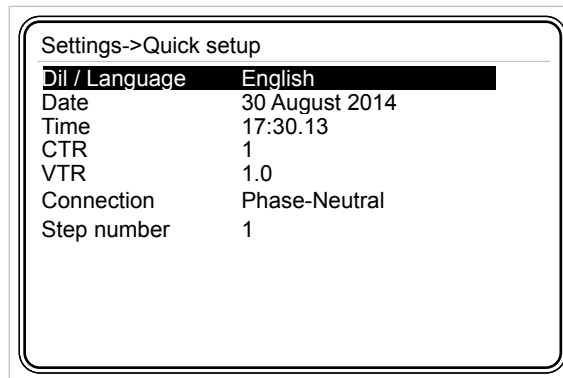

Fig. 3-14 Quick Setup Menu

3.2.1.1.1 Language Setting

Language is selected in this tab (See 3.1.1).

3.2.1.1.2 Date Menu

Date setting is performed here (See 3.1.2).

3.2.1.1.3 Time Menu

Time setting is performed here (See 3.1.3).

3.2.1.1.4 CTR

Current transformer ratio is entered here (See 3.1.4).

3.2.1.1.5 VTR

Voltage transformer ratio is entered here (See 3.1.5).

3.2.1.1.6 Connection

Connection type can be adjusted here (See 3.1.6).

3.2.1.1.7 Step number

RAPIDUS activates a 3-phase capacitor when it learns the connections. You shall enter the 3-phase capacitor number to be used for learning the connections in this menu.

In order to store the new settings in the nonvolatile memory, you shall return back to the "Startup Screen" from the tab where the changes are made using X key. Press OK when "Settings changed. Save?" message is displayed on the Screen. Thus, the changes are saved and stored in the nonvolatile memory. The changes shall not be saved and stored in the nonvolatile memory if X key is pressed.

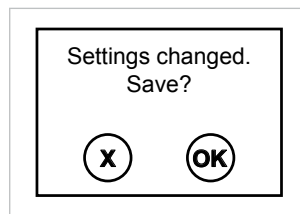

Fig. 3-15 RAPIDUS Prompt for saving



Changes shall be saved on the nonvolatile memory if you press OK when "Settings changed. Save?" message is displayed on the Screen. The changes shall not be saved and stored in the nonvolatile memory if X key is pressed.



3.2.1.2 Setup Menu

Sub-menus below are available under the setup tab:

- Network
- Step
- Compensation
- Learning
- Aux. input
- Device
- Energy
- Communication
- Alarm
- Clear

User may navigate inside the menu using up and down arrow keys, and access the contents of the menus (sub-menus under the setup menu) by pressing OK.

3.2.1.2.1 Network Menu

This menu is used for performing the network settings.

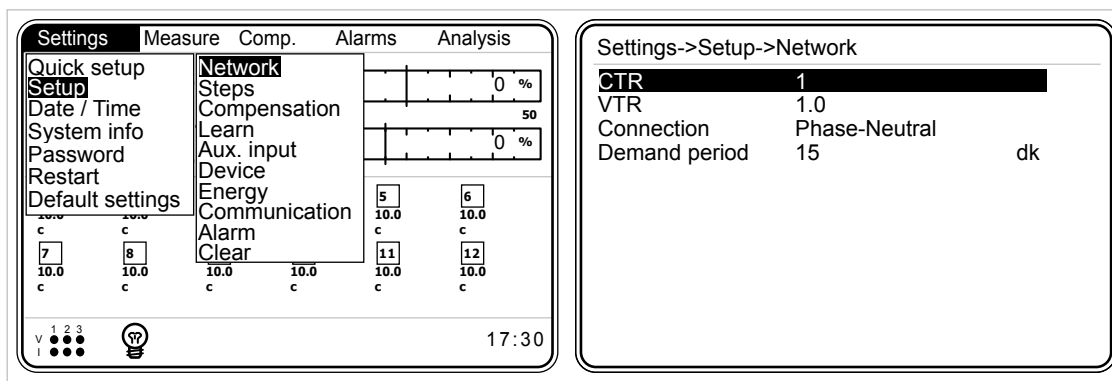

Fig. 3-16 Network Menu

3.2.1.2.1.1 CTR Setting

This is the settings tab for entering the current transformer ratio. Current transformer ratio may be selected between 1 and 5000. (For the usage of RAPIDUS Virtual Keyboard, See 3.1.4 Example)

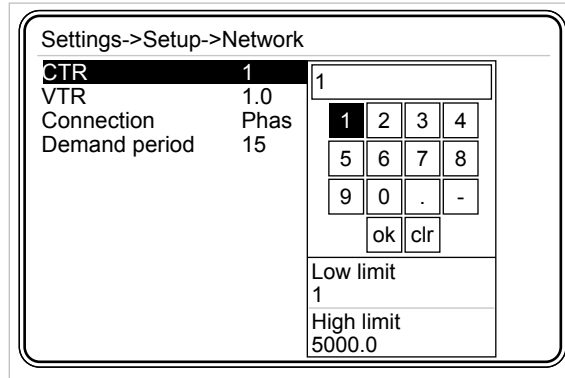

Fig. 3-17 Current Transformer Ratio Setting



Current transformer ratio shall be entered correctly to ensure that RAPIDUS performs a correct measurement.

3.2.1.2.1.2 VTR Setting

This is the settings tab for entering the voltage transformer ratio. Voltage transformer ratio maybe selected between 1.0 and 5000.0. (For the usage of RAPIDUS Virtual Keyboard, [See 3.1.4 Example](#)). If you will enter a number with a decimal place for voltage transformer ratio, select the box on the Virtual Keyboard with arrow keys and press OK.



Voltage transformer ratio shall be entered correctly to ensure that RAPIDUS performs a correct measurement.

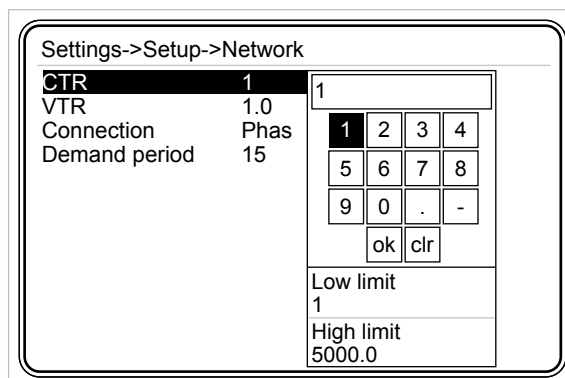
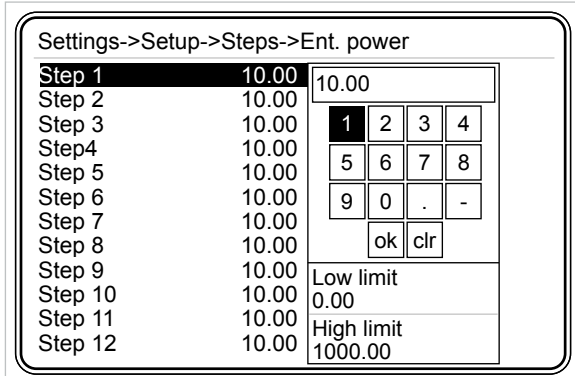

Fig. 3-18 Voltage Transformer Ratio Setting

Step powers learned by RAPIDUS are indicated in this menu. Also, user may enter/change all step powers manually using this menu.



NOTE: There are two Ent. Power sub menus for RAPIDUS 212R. Operator can assign 1st, 2nd, ... and 12th step powers in "Ent. Power 1" Submenu. Operator can assign 13th, 14th, ...and 24th step powers in "Ent. Power 1" Submenu.

Fig. 3-21 Ent. Power Menu

3.2.1.2.2.2 Ent. Type Menu

Step types learned by RAPIDUS are indicated or user may set the step powers in this menu.

- "C" is for 3-phase capacitor,
- "L" is for 3-phase shunt reactor,



You shall check whether RAPIDUS has learned step types correctly from this menu. If RAPIDUS has not learned step types correctly, perform one of the following.

- RAPIDUS is commanded to learn the steps again (See 3.2.3.6 Learn Steps Menu)
- Step types are corrected manually. (See Fig. 3-21)

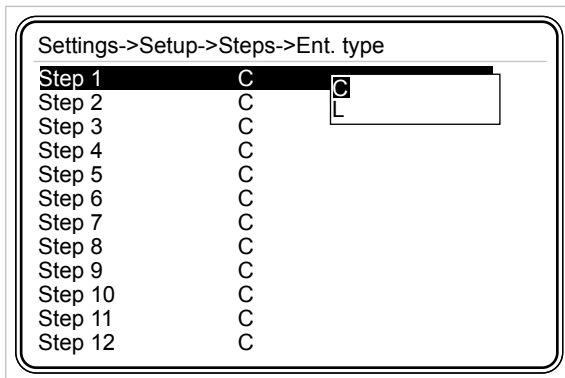

NOTE: There are two "Ent. Type" submenus for RAPIDUS 212R. Operator can assign 1st, 2nd, ... and 12th step powers in "Ent. Type 1" Submenu. Operator can assign 13th, 14th,...and 24th step powers in "Ent. Type 1" Submenu.

Fig. 3-22 Ent. Type Menu

3.2.1.2.2.3 Predefined Menu

Step settings may be performed as per a predefined structure. Relevant settings are performed on the following three sub-menus specified below for predefined menu.

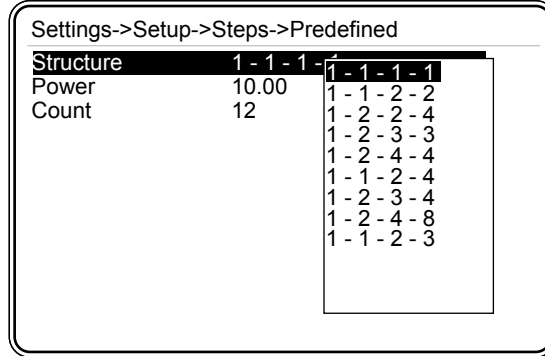

Fig. 3-23 Predefined Menu

3.2.1.2.2.3.1 Structure Menu

Following options are available on the step structure

- 1.1.1.1.1.1.....
- 1.1.2.2.2.2.....
- 1.2.2.4.4.4.....
- 1.2.3.3.3.3.....
- 1.2.4.4.4.4.....
- 1.1.2.4.4.4.....
- 1.2.3.4.4.4.....
- 1.2.4.8.8.8.....
- 1.1.2.3.3.3.....

3.2.1.2.2.3.2 Power Menu

Power of the first step is entered in kVAR. RAPIDUS calculates the step powers after the first step as per the selected template selected in the structure menu.

3.2.1.2.2.3.3 Number Menu

Number of steps in the template selected in structure is set in this menu.

Example:

Assume that 1.2.4.8 is selected as the structure, and 10 kVAR is entered as the power (RAPIDUS takes this value as the 1st step power), and 8 is entered as the number. Then, step powers shall be as follows:

- 1st step: 10 kVAR
- 2nd step: 20 kVAR
- 3rd step: 40 kVAR

- 4th step: 80 kVAR
- 5th step: 80 kVAR
- 6th step: 80 kVAR
- 7th step: 80 kVAR
- 8th step: 80 kVAR

3.2.1.2.2.4 Other Menu

Discharge time is entered here. RAPIDUS waits for the discharge time before reactivating a step that it has deactivated.

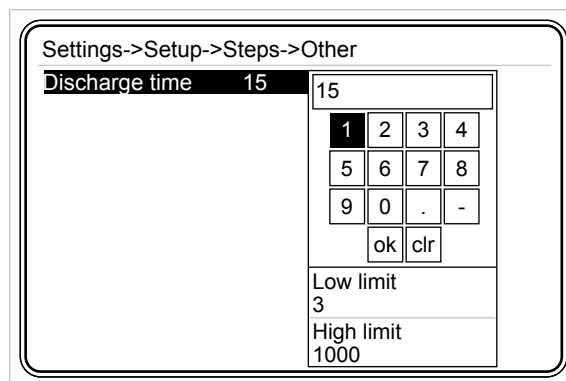

Fig. 3-24 Other Menu

3.2.1.2.3 Compensation Menu

Compensation menu is composed of the tabs shown in Fig. 3-25.

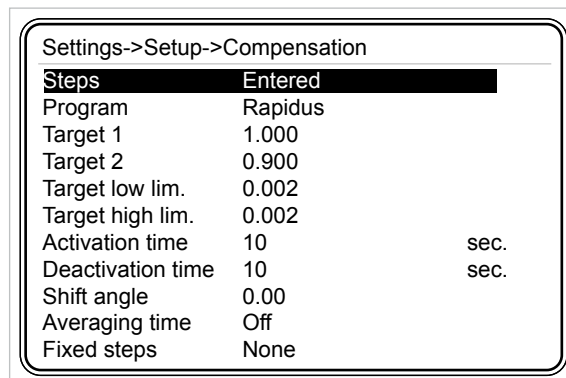

Fig. 3-25 Compensation Menu



3.2.1.2.3.1 Steps Menu

RAPIDUS activates and deactivates steps when it performs reactive power compensation. Step types and power values are determined with 3 different methods.

Entered:

User has entered step values manually to RAPIDUS (See 3.2.1.2.2.1 Ent. Power). RAPIDUS uses these values if “Entered” is selected.

Predefined:

User has entered the step power as described in predefined menu (See 3.2.1.2.2.3 Predefined). RAPIDUS uses these values if “Predefined” is selected.

DCM (Dynamic Capacitor Monitoring):

RAPIDUS follows the step values dynamically. DCM algorithm runs on the background continuously.

When user selects “DCM” option on the “Steps” tab, RAPIDUS uses the step values that it dynamically monitors and updates for compensation.

NOT: DCM(Dynamic Capacitor Monitoring) feature isn't available in RAPIDUS 212R.

3.2.1.2.3.2 Program Menu

RAPIDUS has compensate with 6 different programs.

Rapidus Asc. Sequential, Des. Sequential, Linear and Circular options are programs with their own algorithms.

In the manual option, operator may activate and deactivate any step; RAPIDUS does nothing more than allowing manual access to the operator in this program.

Following features are available in all compensation programs other than “Manual”:

- User may enter any capacitor or shunt reactor to RAPIDUS in any order or to any step.
- RAPIDUS does not use (ignores) the steps that it has learned as “0” or that is entered by the user as “0”.

Settings->Setup->Compensation		
Steps	Entered	Rapidus
Program	Rapidus	Asc. sequential Des. sequential Linear Circular Manual
Target 1	1.000	
Target 2	0.900	
Target low lim.	0.002	
Target high lim.	0.002	
Activation time	10	sec.
Deactivation time	10	sec.
Shift angle	0.00	
Averaging time	Off	
Fixed steps	None	

Fig. 3-26 Program Menu

3.2.1.2.3.2.1 Rapidus Program

The compensation program selected in the default settings (factory settings) of RAPIDUS is the "Rapidus" option. It activates the step combination closest to the measured demand.

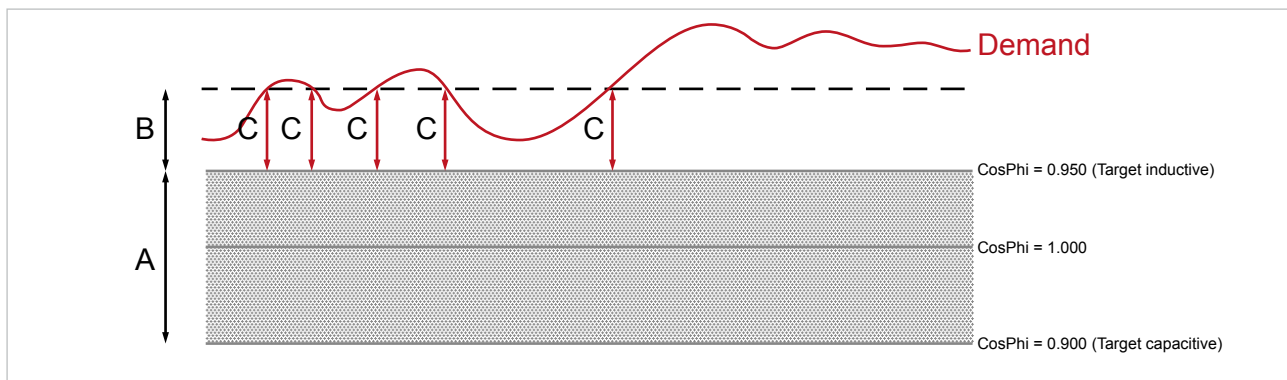

Fig. 3-27 RAPIDUS Mode Compensation Steps

On the diagram above:

A: Reactive power interval corresponding to the measured $\text{Cos}\phi$ values.

B: Limit value decided for compensation by RAPIDUS (calculated as per automatic C/K ratio).

C: Reactive power value to be compensated.

When the system is in interval, RAPIDUS does not compensate. When the system is in this interval, activation and deactivation counters of RAPIDUS are not active.

RAPIDUS starts to activate a step after an "activation time" (See 3.2.1.2.3.7 Activation time) when the system reactive power requirement reaches over B point.

Similarly, RAPIDUS starts to deactivate a step after a "deactivation time" (See 3.2.1.2.3.8 Deactivation time) when the system reactive power requirement is decreased under B point.

3.2.1.2.3.2.2 Ascending Sequential program

Step activation and deactivation operations are performed by starting from the step with the lowest power (ascending sequential). When activation/deactivation is required, only one step is activated/deactivated. Then reactive power is calculated again. If activation/deactivation demand is continued, next step with the lowest power is activated/deactivated.

- **When the System is Inductive**

If a shunt reactor is activated, RAPIDUS deactivates steps one by one until the demand is met starting with the shunt reactor with the lowest power.

Assume all shunt reactors are deactivated and system is still inductive. RAPIDUS activates steps starting with the capacitor step with the lowest power.

- **When the System is Capacitive**

If a capacitor is activated, RAPIDUS deactivates all steps one by one until the demand is met starting with the capacitor with the lowest power.

Assume all capacitors are deactivated and system is still capacitive. RAPIDUS activates steps starting with the shunt reactor step with the lowest power.

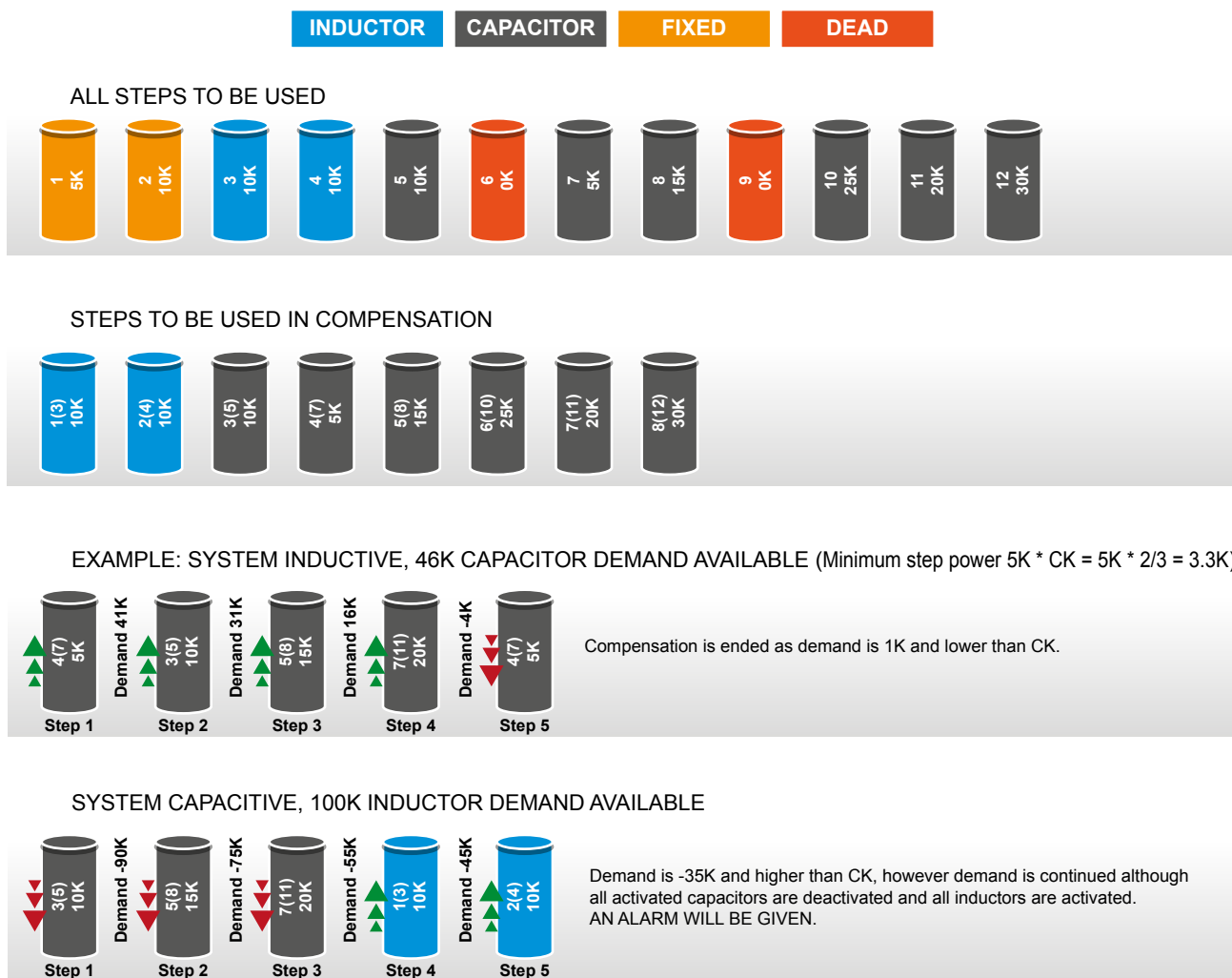

Fig. 3-28 RAPIDUS Asc. Sequential Mode

3.2.1.2.3.2.3 Descending Sequential Mode

RAPIDUS performs activation/deactivation operation starting with the step closest to the demand. When activation/deactivation is required, only one step is activated/deactivated. Then reactive power is calculated again. If activation/deactivation demand is continued, next step closest to the demand is activated/deactivated.

- **If the System is Inductive:**

If a shunt reactor is activated, steps are deactivated one by one until the demand is met starting with the shunt reactor closest to the demand.

If system is still inductive although all shunt reactors are deactivated, and there are capacitor steps that are not active, steps are activated one by one until the demand is met starting with the capacitor step closest to the demand.

- **If the System is Capacitive:**

If a capacitor is activated, steps are deactivated one by one until the demand is met starting with the capacitor closest to the demand.

If system is still capacitive although all capacitors are deactivated, and there are shunt reactor steps that are not active, steps are activated one by one until the demand is met starting with the shunt reactor step closest to the demand.

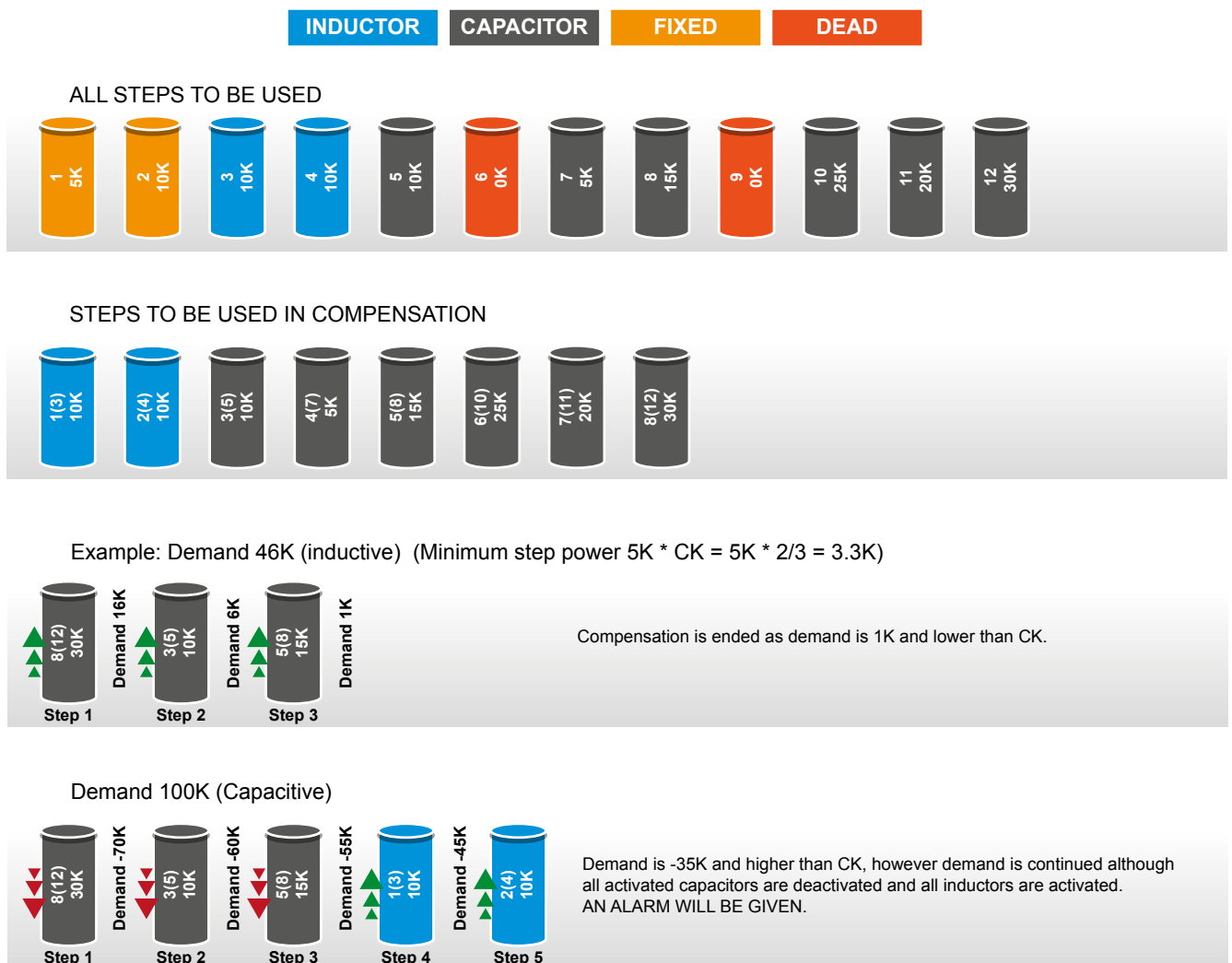

Fig. 3-29 RAPIDUS Des. Sequential Mode



3.2.1.2.3.2.4 Linear Mode



Linear program is used in panels with the step structure 1.1.1.1.

The step activated first is deactivated last in linear program.

- **If the System is Inductive:**

If there are shunt reactors activated, the number of shunt reactors that will the demand shall be deactivated. If the system is still inductive although all shunt reactors are deactivated, the number of capacitors required shall be activated.

- **If the System is Capacitive:**

If there are capacitors activated, the number of capacitors that will the demand shall be deactivated. If the system is still capacitive although all capacitors are deactivated, the number of shunt reactors required shall be activated.

INDUCTOR

CAPACITOR

FIXED

DEAD

ALL STEPS TO BE USED

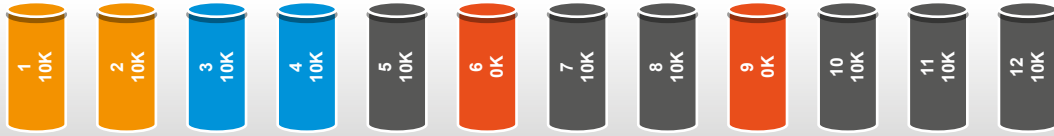

STEPS TO BE USED IN COMPENSATION

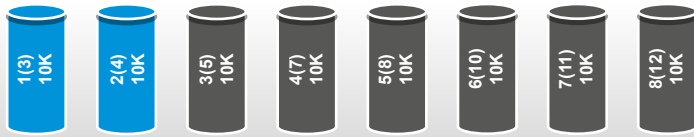

Example: SYSTEM INDUCTIVE, 46K CAPACITOR DEMAND AVAILABLE (Minimum step power $10K * CK = 10K * 2/3 = 6.7K$)

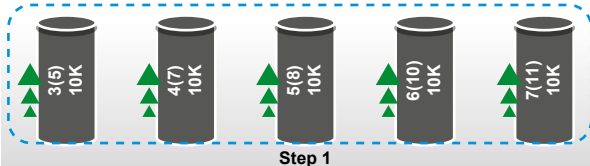

Compensation is ended as demand is -4K and lower than CK.

SYSTEM CAPACITIVE, 20K INDUCTOR DEMAND AVAILABLE

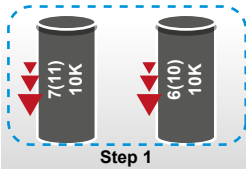

Compensation is ended as demand is 0K and lower than CK.

SYSTEM CAPACITIVE, 40K INDUCTOR DEMAND AVAILABLE

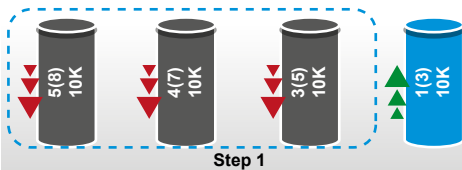

Compensation is ended as demand is 0K and lower than CK.

SYSTEM CAPACITIVE, 20K INDUCTOR DEMAND AVAILABLE

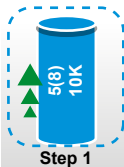

Compensation Demand is continued as demand is -10K and higher than CK. However, there are no inductors to activate nor capacitors to deactivate. AN ALARM WILL BE GIVEN.

Fig. 3-30 RAPIDUS Linear Mode



3.2.1.2.3.2.5 Circular Mode



Circular program is used in panels with the step structure 1.1.1.1.

The step activated first is deactivated first in circular program.

- **If the system is inductive:**

If there are shunt reactors activated, the number of shunt reactors that will the demand shall be deactivated. If the system is still inductive although all shunt reactors are deactivated, the number of capacitors required shall be activated.

- **If the system is capacitive:**

If there are capacitors activated, the number of capacitors that will the demand shall be deactivated. If the demand is resumed although all capacitors are deactivated, the number of shunt reactors required shall be activated.

INDUCTOR

CAPACITOR

FIXED

DEAD

ALL STEPS TO BE USED

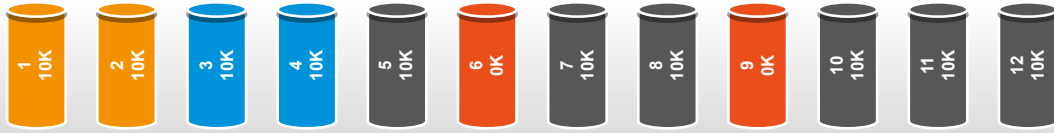

STEPS TO BE USED IN COMPENSATION

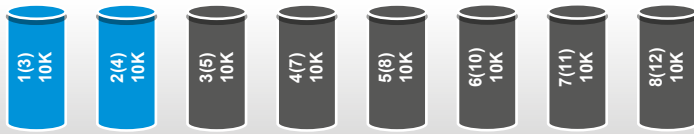

Example: SYSTEM INDUCTIVE, 46K CAPACITOR DEMAND AVAILABLE (Minimum step power $10K * CK = 10K * 2/3 = 6.7K$)

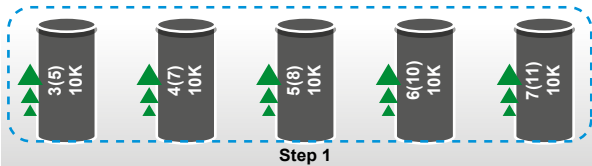

Compensation is ended as demand is -4K and lower than CK.

SYSTEM CAPACITIVE, 30K INDUCTOR DEMAND AVAILABLE

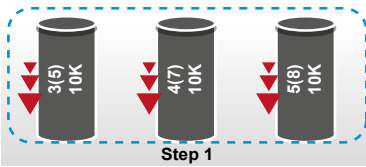

Compensation is ended as demand is 0K and lower than CK.

SYSTEM INDUCTIVE, 20K CAPACITOR DEMAND AVAILABLE

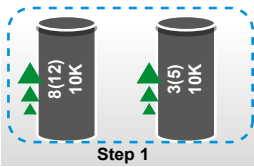

Compensation is ended as demand is 0K and lower than CK.

SYSTEM CAPACITIVE, 60K INDUCTOR DEMAND AVAILABLE

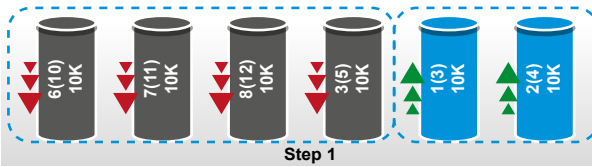

Compensation is ended as demand is 0K and lower than CK.

SYSTEM INDUCTIVE, 90K CAPACITOR DEMAND AVAILABLE

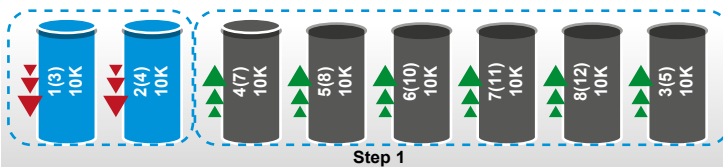

Demand is -10K, however, there are no inductors to activate nor capacitors to deactivate although the demand is continued. AN ALARM WILL BE GIVEN.

Fig. 3-31 RAPIDUS Circular Mode

3.2.1.2.3.2.6 Manual program



RAPIDUS does not perform automatic compensation when it is taken in manual mode.

When manual program is active, a “hand” symbol is displayed on the lower left corner of the main menu page. This symbol indicates that RAPIDUS is in manual compensation mode.

Manual mode is activated by pressing down arrow when you are in main menu screen. The step that shall be activated is highlighted with arrow keys and OK key is pressed. Thus, step shall be activated. Step shall be deactivated when you highlight the step that will be deactivated and press OK. If an hourglass symbol is displayed while the step is being activated, this indicates that discharge time is waited to activate the step.

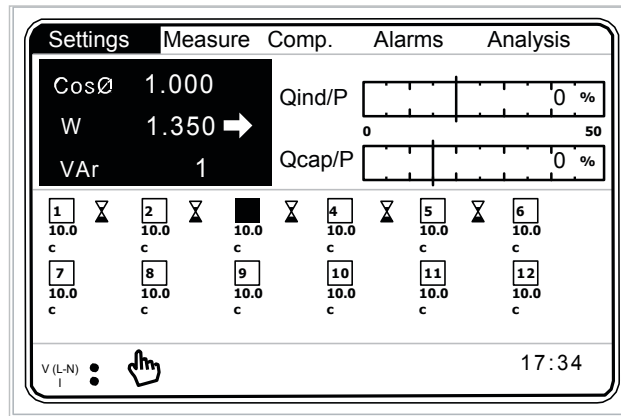

Fig. 3-32 Manual Mode Menu

Operator can reach step’s information in manual program menu. Operator should press “OK” key when the related step is highlighted.

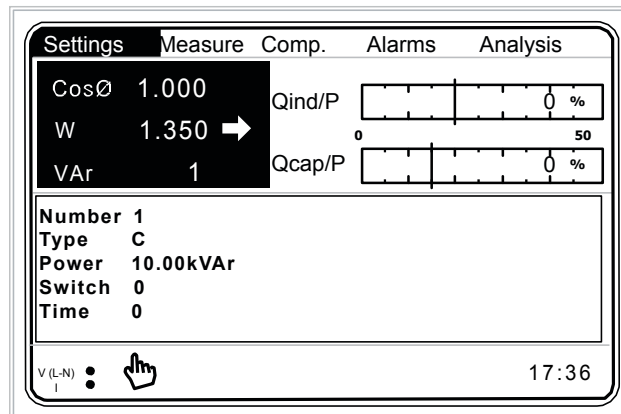

Fig. 3-33 Manual mod for RAPIDUS 212R

If operator press "OK" key again, the related step will be activated.

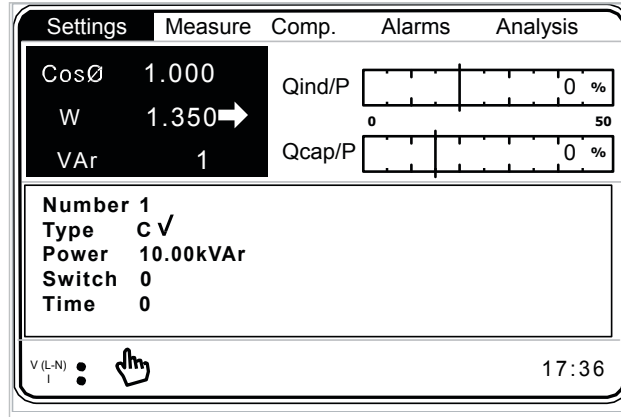

Fig. 3-34 Manual mod activated relay for RAPIDUS 212R

3.2.1.2.3.3 Target 1 Menu

Target 1 CosΦ value is set here. It can be set between -0.800 and 0.800.

Negative value indicates capacitive target, positive value indicates inductive target.

3.2.1.2.3.4 Target 2 Menu

Target 2 CosΦ value is set here. It can be set between 0.800 and 1.000.

Positive value indicates inductive target.

For this feature to be active:

- Operator should change Mod tab of "Settings->Setup->Aux. input" setting to either of the following

Night/day

Generator

- GEN input should be activated with 85-265VAC.



3.2.1.2.3.5 Target Low Lim. Menu

It is the lower tolerance value for target 1 and target 2 settings. It can be set between 0.000 and 0.200.

3.2.1.2.3.6 Target High Lim. Menu

It is the upper tolerance value for target 1 and target 2 settings. It can be set between 0.000 and 0.200.

3.2.1.2.3.7 Activation Time Menu

RAPIDUS waits for the “activation time” before activating a step. Activation time may be selected between 1 and 600 seconds.

3.2.1.2.3.8 Deactivation Time Menu

RAPIDUS waits for the “deactivation time” before deactivating a step. Deactivation time may be selected between 1 and 600 seconds.

3.2.1.2.3.9 Shift Angle Menu

By entering the shift angle, changes in reactive power (transformer losses) that occur before the RAPIDUS measurement point are compensated.

Shift angle is set from -45° to 45° . RAPIDUS adds the reactive power that it calculates with the shift angle to the reactive power that it calculates by measuring the system voltage and current. Then it calculates the $\cos\phi$ value and compensates.

Index values vary as per shift angle.

Example 1:

Assume that the $\cos\phi$ value indicated by RAPIDUS is 1.000.

When the user enters 20° as the shift angle, RAPIDUS shall calculate $\cos\phi$ value as 0.940 inductive.

When the user enters -30° as the shift angle, RAPIDUS shall calculate $\cos\phi$ value as 0.866 capacitive.

3.2.1.2.3.10 Averaging Time

After accomplishing its measurements, RAPIDUS can quickly decide whether there is a need to switch in or out step(s). In summary, RAPIDUS is a quick responding reactive power controller.

If the operator does not require RAPIDUS to respond quickly, operator should adjust the device via this tab.

RAPIDUS takes average of the measured power during the adjusted interval (5 sec. – 60 sec.). Just after the adjusted time interval elapses, RAPIDUS compensates according to the calculated average power.

This setting will increase response time of RAPIDUS. However, on the other side, this setting will lengthen the lifetime of switch gear of the system. This is a compromise of opposite requirements, and it changes from system to system.”

Settings->Setup->Compensation		
Steps	Entered	Off
Program	Rapidus	5 sec.
Target 1	1.000	10 sec.
Target 2	0.900	20 sec.
Target low lim.	0.002	30 sec.
Target high lim.	0.002	40 sec.
Activation time	10	50 sec.
Deactivation time	10	60 sec.
Shift angle	0.00	
Averaging time	Off	
Fixed steps	None	

Fig. 3-35 Averaging Time Menu

3.2.1.2.3.11 Fixed Steps Menu

First three steps of RAPIDUS may be assigned as fixed steps. On the main menu screen, “↓” symbol is displayed next to the step assigned as fixed symbol.

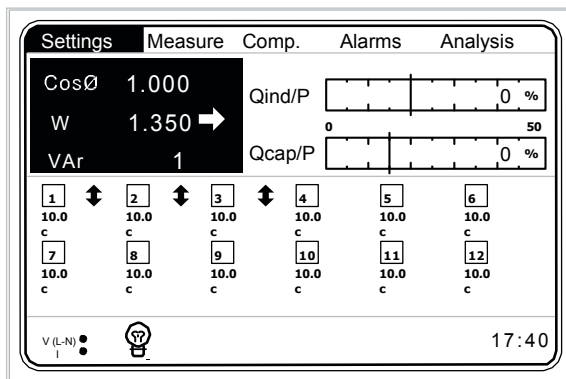

Fig. 3-36 Fixed Steps Menu

3.2.1.2.4 Learn Menu

Settings for learning of steps and connections by RAPIDUS are performed from this menu.

3.2.1.2.4.1 Learn Conn. Menu

Settings for learning of current and voltage connections by RAPIDUS are performed here.

3.2.1.2.4.1.1 Learn at start

On => RAPIDUS learns connections automatically when it is turned on or restarted.

Off => RAPIDUS does not learn connections automatically when it is turned on or restarted.

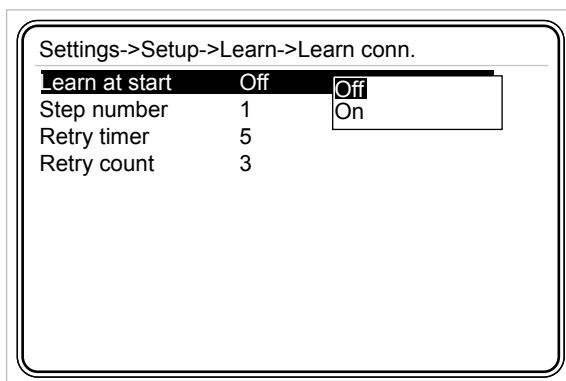

Fig. 3-37 Connection Setup

If the connections shall not be learned at start up, we advise them to be learned manually. This procedure is performed at "Compensation->Learn conn." menu. (See [3.2.3.4 Learn Conn. Menu](#))

Current threshold values for transformers vary according to type and size of the current transformers used. Please check that the measured current value is higher than the threshold specified in the technical specifications of current transformer. Otherwise Rapidus learn algorithm may not be completed or may be completed even if the connections are incorrect.



In cases where electrical system is unbalanced and/or there are sudden load changes, “learn algorithm” can be completed in an erroneous result. In such a situation, active powers measured by Rapidus will also be positive (checking active powers will not help). Therefore, it is important that operator should also physically check connections.

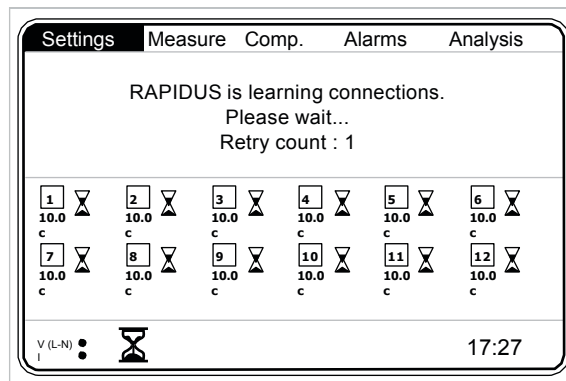

Fig. 3-38 Learning Connections at the Startup

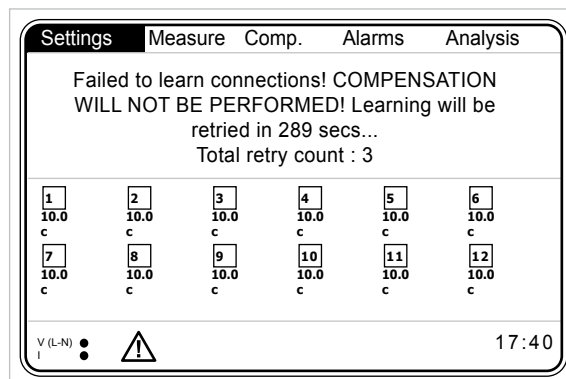

Fig. 3-39 Waiting Time After Unsuccessful Connection Learning

3.2.1.2.4.1.2 Step number

RAPIDUS learns the connections by activating a 3-phase capacitor.

We advise you to enter the step number that the capacitor with the highest power value is connected.



If the number of a step that is determined as faulty by RAPIDUS is entered to “Step number” setting, an error/warning message shall be displayed on the screen.

3.2.1.2.4.1.3 Retry Timer

If RAPIDUS could not learn the connection after making retries equal to the “Retry number”, it waits for the set retry timer without compensating. Then (after the “Retry timer”), it tries to learn the connections. This cycle is continued until the connections are learned.

While waiting for the “Retry timer”, RAPIDUS continues to make measurements and display these measurements on its screen, but it does not compensate.

If user does not want to wait during the retry timer, he/she can manually command from “Comp.->Learn conn.”

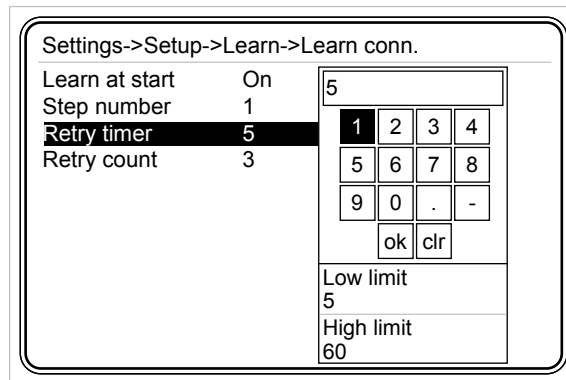

Fig. 3-40 Retry Timer

3.2.1.2.4.1.4 Retry Number

When it cannot learn the connection at startup, RAPIDUS it tries to learn the connections for times equal to the “Retry Number”.

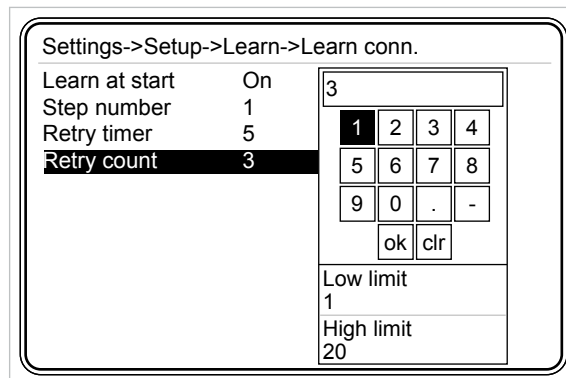

Fig. 3-41 Retry Count

3.2.1.2.4.2 Learn Step Menu

Settings for learning of current and voltage connections by RAPIDUS are performed here.

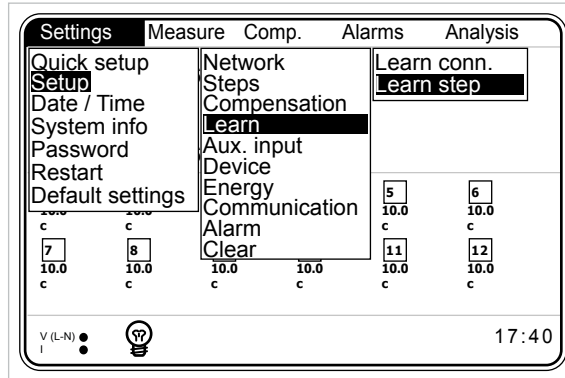

Fig. 3-42 Learn step

3.2.1.2.4.2.1 Learn at start

On => RAPIDUS learns step powers automatically when it is turned on or restarted.
 Off => RAPIDUS does not learn step powers automatically when it is turned on or restarted.



If it is used as "On", step powers are learned again and again when Rapidus is restarted or powered on. After step powers are learned by Rapidus, it is highly recommended to use this setting as "Off". Otherwise step powers can be learned wrongly. Besides, factory setting is "Off" as well.

3.2.1.2.4.3 Aux. Input Menu

Aux. input menu is used to ensure that, RAPIDUS compensates as per the secondary target $\cos\phi$.

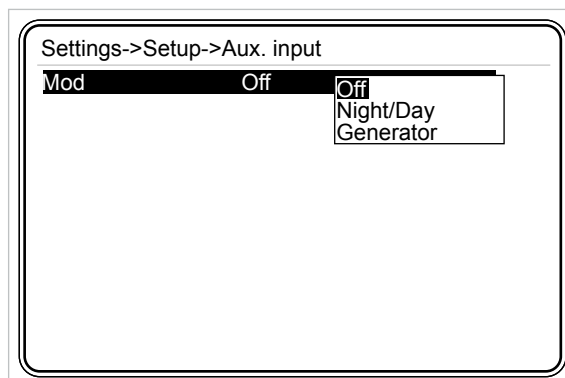

Fig. 3-43 Aux. Input

3.2.1.2.4.4 Off mode

If the digital input mode is selected as "Off", GEN input shall not affect running of RAPIDUS. RAPIDUS compensates as per "Target 1 Inductive" and "Target 1 Capacitive" values.

3.2.1.2.4.5 Night/Day Mode

If aux. input mode is selected as “Night/Day”, compensation is performed as per “Target 2 Inductive” and “Target 2 Capacitive” values when GEN input is active. Energy menu counters count independent of the GEN input.

3.2.1.2.4.6 Generator Mode

If aux. input mode is selected as “Generator”, compensation is performed as per the set “Target 2 Inductive” and “Target 2 Capacitive” values when GEN input is active. Then, energy menu counters (See 3.2.1.2.6 Energy Menu) do not count.

3.2.1.2.5 Device Menu

This menu is used for performing the following settings.

- Language
- Contrast
- Pass. protection
- New password
- Display on
- Display on time

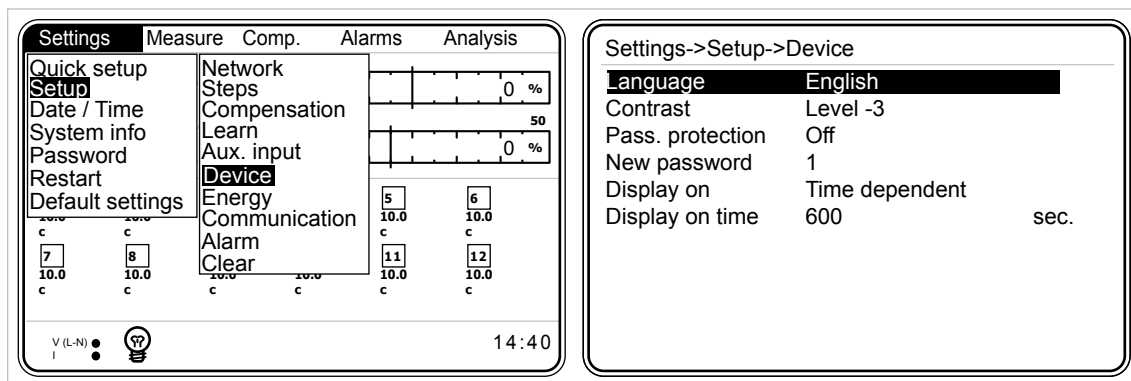

Fig. 3-44 Device Menu

3.2.1.2.5.1 Language Setting

- Türkçe
- English
- Русский

User shall select the desired setting with up and down arrows and press "OK".

3.2.1.2.5.2 Contrast Setting

This menu is used for performing the contrast setting. Level setting steps are displayed when you press OK when this option selected. User shall select the desired contrast level with up and down arrows and press "OK". RAPIDUS screen gets darker when you go up to level 4. RAPIDUS screen gets lighter when you go down to level -4.

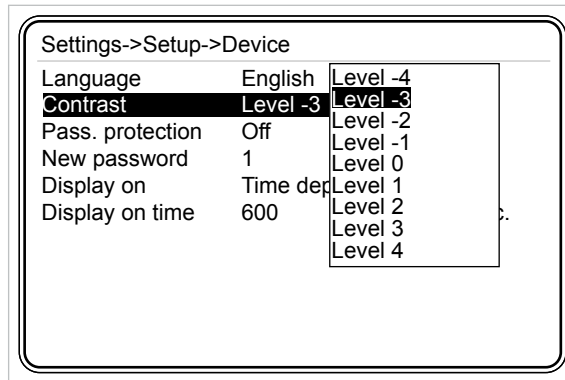

Fig. 3-45 Contrast Setting

3.2.1.2.5.3 Pass. Protection

If password protection is selected as "On", you shall enter a password in order to enter the setting menus each time RAPIDUS is restarted again.

If password protection is selected as "Off", you do not need to enter a password in order to enter the setting menus each time RAPIDUS is restarted again.

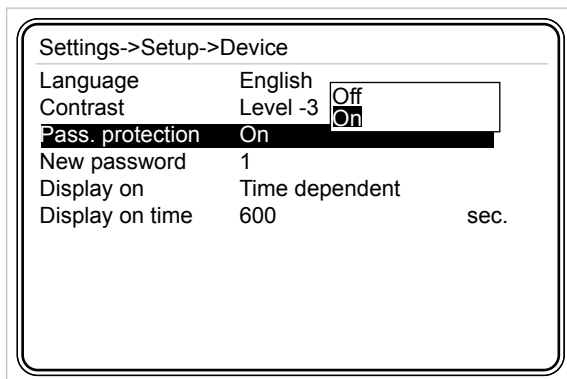

Fig. 3-46 Pass. Protection

3.2.1.2.5.4 New Password Setting

Factory set password of RAPIDUS is “1”. New password may be selected between 1 and 9999. (For the usage of RAPIDUS Virtual Keyboard, [See 3.1.4 Example](#))

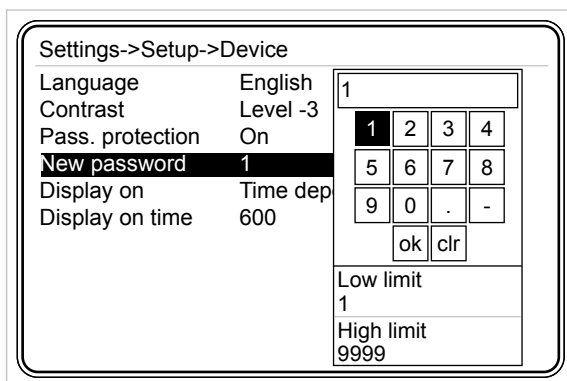

Fig. 3-47 New Password Entry

3.2.1.2.5.5 Display On Setting

- Continuous
- Time dependent

When continuous is selected, the backlight of RAPIDUS display does not turn off. When time dependent is selected, screen backlight is turned on for “display on time”.

3.2.1.2.5.6 Display On Time Setting

This tab is used for setting the on time for the backlight of RAPIDUS display. It may be selected between 10 and 600 seconds. (For the usage of RAPIDUS Virtual Keyboard, [Refer to 3.1.4 Example](#))

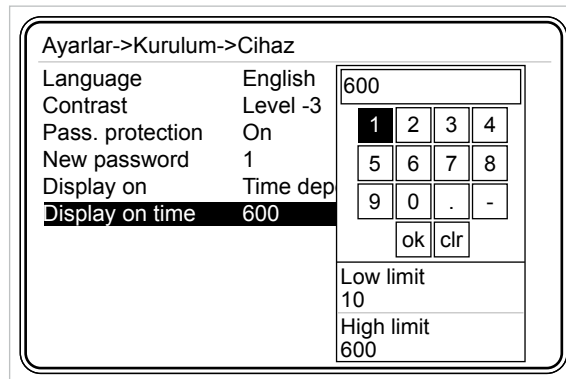

Fig. 3-48 Display On Time Setting

3.2.1.2.6 Energy Menu

This menu is used for entering the initial energy values. The settings in this menu are used for synchronization of system electricity counter and RAPIDUS counters. User shall select the desired energy value with up and down arrows and press "OK".

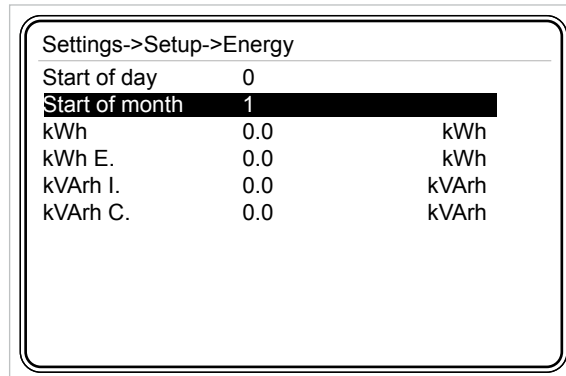

Fig. 3-49 Energy Menu

3.2.1.2.6.1 Start of day setting

This is the settings tab for entering the time for start of the day. Start of the day time may be selected between 0 and 23. (For the usage of RAPIDUS Virtual Keyboard, [See 3.1.4 Example](#))

3.2.1.2.6.2 Start of month setting

This is the settings tab for entering the day for start of the month. Start of month day may be selected between 1 and 28. (For the usage of RAPIDUS Virtual Keyboard, [See 3.1.4 Example](#))

The settings listed below between 3.2.1.2.6.3 and 3.2.1.2.6.6 are used for synchronization of system electricity counter and RAPIDUS counter. Each of them may be set between 0.0 and 20000000000.0. (For the usage of RAPIDUS Virtual Keyboard, [See 3.1.4 Example](#)).

3.2.1.2.6.3 kWh Setting

This tab is used for entering the “initial” value for imported active energy.

3.2.1.2.6.4 kWh E. Setting

This tab is used for entering the “initial” value for exported active energy.

3.2.1.2.6.5 kVArh I. Setting

This tab is used for entering the “initial” value for inductive reactive energy.

3.2.1.2.6.6 kVArh C. Setting

This tab is used for entering the “initial” value for capacitive reactive energy.

3.2.1.2.7 Communication Menu

RAPIDUS includes Modbus RTU communication protocol. Settings related with Modbus protocol are made in this menu.

3.2.1.2.7.1 Baud Rate Menu

“User shall select the desired value with up and down arrows and press “OK”. RAPIDUS communicates with speeds of 2400, 4800, 9600, 19200, 38400, 57600 and 115200 bits/second.”

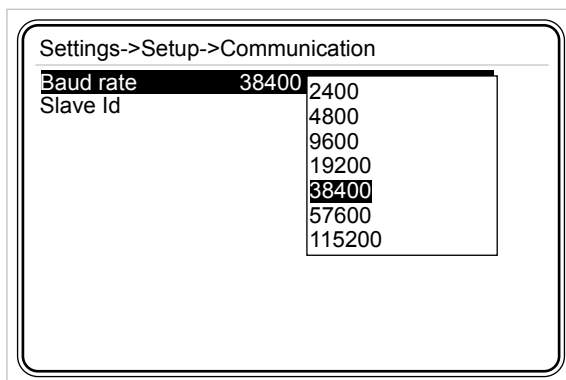

Fig. 3-50 Baud Rate Setting

3.2.1.2.7.2 Slave Id Menu

This is the settings tab for entering the slave id number. (For the usage of RAPIDUS Virtual Keyboard, Refer to 3.1.4 Example).

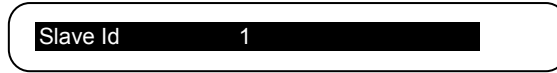

Fig. 3-51 Slave Id Setting

Maximum 247 devices may communicate over the same RS485 line. Therefore, slave id may be selected between 1 and -247.

3.2.1.2.8 Alarm Menu

User may navigate in the alarm settings menu using up and down arrow keys, and access the contents of the sub-menus of alarm menu by pressing OK.

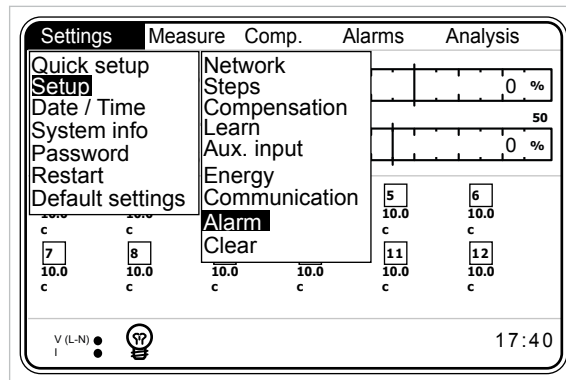

Fig. 3-52 Alarm Menu

3.2.1.2.8.1 Energy Alarm Menu

This menu is used for performing the upper limit alarm settings of Inductive/Active and Capacitive/Active ratios. User may navigate in Energy alarms menu with up and down arrows.

Settings->Setup->Alarm->Energy		
Inductive hi limit	20.0	%
Alarm relay	Off	
Capacitive hi limit	15.0	%
Alarm relay	Off	

Fig. 3-53 Energy Menu

$$\text{Inductive hi limit} = \frac{\text{Inductive reactive energy}}{\text{Active energy}} \times 100$$

$$\text{Capacitive hi limit} = \frac{\text{Capacitive reactive energy}}{\text{Active energy}} \times 100$$

Refer to descriptions of V(L-N) Alarm menu for the alarm relay setting.

3.2.1.2.8.2 VAlarm Menu

This sub-menu is used for voltage alarm settings. User may navigate in V alarms menu with up and down arrows.

Settings->Setup->Alarm->V		
Alarm relay	Off	
Low limit	0.0	V
High limit	0.0	V
Delay	0	sec.
Hysteresis	0.0	%

Fig. 3-54 V Alarm Menu

Alarm relay:

This setting is used for regulation of pulling of the relays when an alarm occurred only. In order to ensure that RAPIDUS gives a V (L-N) alarm, lower and upper limit values shall be set as described below.

Alarm relay options:

Off: No alarm relay is pulled in case of an alarm
 Relay1 : Only relay 1 is pulled in case of an alarm
 Relay2 : Only relay 2 is pulled in case of an alarm

User shall select the desired setting with up and down arrows and press "OK".

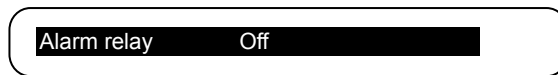

Fig. 3-55 Alarm Relay Setting

If Voltage go out of low or high limit, RAPIDUS gives an alarm

Low Limit:

This tab is used for entering alarm low limit. (For the usage of RAPIDUS Virtual Keyboard, See 3.1.4 Example). In order to set an alarm for V values, user shall enter a smaller low limit than high limit. If low limit and high limit values entered are the same, V parameter is closed for alarms.

High Limit:

This tab is used for entering alarm high limit. (For the usage of RAPIDUS Virtual Keyboard, See 3.1.4 Example). In order to set an alarm for V values, user shall enter a higher high limit than low limit. If low limit and high limit values entered are the same, V parameter is closed for alarms.

Delay:

RAPIDUS waits for the delay time before giving an alarm when the related alarm parameter exceeds "Low limit" or "High limit" value. Also, RAPIDUS waits for the delay time again before cancelling an alarm condition when the related alarm parameter returns back in the limits. It may be selected between 0 and 600 seconds. (For the usage of RAPIDUS Virtual Keyboard, See 3.1.4 Example).

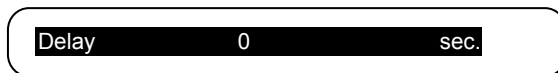

Fig. 3-56 Alarm Time Setting

Hysteresis setting:

This is the tolerance value entered in %. Refer to the example below and Fig. 3-56 for the usage method. It may be selected between 0.0 and 20.0. (For the usage of RAPIDUS Virtual Keyboard, See 3.1.4 Example)

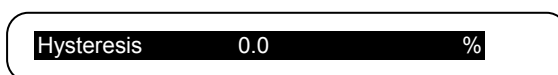

Fig. 3-57 Hysteresis Setting

Example:

For the figure below (delay setting is zero):

- An alarm occurs in point A
- Alarm is cancelled in point B
- An alarm occurs in point C
- Alarm is cancelled in point D

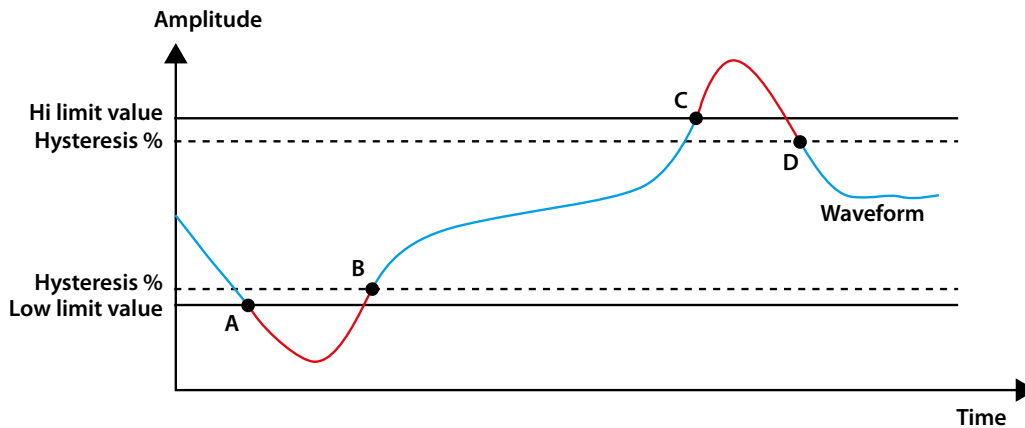

Fig. 3-58 Alarm Example

3.2.1.2.8.3 Current Alarm Menu

This sub-menu is used for current alarm settings. Settings are the same for the settings for Alarm->V menu. (Current low and high limit values: 0.0↔30000.0)

3.2.1.2.8.4 P Alarm Menu

This sub-menu is used for active power alarm settings. Settings are the same for the settings for Alarm->V menu. (P low and high limit values: -10000000000.0↔10000000000.0)

3.2.1.2.8.5 Q Alarm Menu

This sub-menu is used for reactive power alarm settings. Settings are the same for the settings for Alarm->V menu. (Q low and high limit values: -10000000000.0↔10000000000.0)

3.2.1.2.8.6 S Alarm Menu

This sub-menu is used for apparent power settings. Settings are the same for the settings for Alarm->V menu. (S low and high limit values: 0.0↔10000000000.0)

3.2.1.2.8.7 CosØ Alarm Menu

This sub-menu is used for CosØ alarm settings. Settings are the same for the settings for Alarm->V menu. (CosØ low and high limit values: 0.000↔1.000).

3.2.1.2.8.8 PF Alarm Menu

This sub-menu is used for power factor alarm settings. Settings are the same for the settings for Alarm->V menu. (PF low and high limit values: 0.000↔1.000)

3.2.1.2.8.9 Step Alarm Menu

This sub-menu is used for step alarm settings. RAPIDUS gives an alarm when any of the steps used in compensation gets lower than the value calculated with the “low limit” setting (alarm limit).

$$\text{Alarm limit} = \frac{\text{initial value} \times \text{Low limit}}{100}$$

(Step low limit values: 20.0↔100.0)

3.2.1.2.8.10 F Alarm Menu

This sub-menu is used for frequency alarm settings. Settings are the same for the settings for Alarm->V(L-N) menu. (Frequency low and high limit values: 35.0↔70.0)

3.2.1.2.8.11 V Harmonics Alarm Menu

This sub-menu is used for harmonics alarm settings. User shall select the desired tab with up and down arrows and press “OK”.

Settings->Setup->Alarm->Harmonics V

Alarm relay	Off	Off
THDV hi limit	0.0	
V3 hi limit	0.0	
V5 hi limit	0.0	
V7 hi limit	0.0	%
V9 hi limit	0.0	%
V11 hi limit	0.0	%
V13 hi limit	0.0	%
V15 hi limit	0.0	%
V17 hi limit	0.0	%
V19 hi limit	0.0	%
V21 hi limit	0.0	%

Fig. 3-59 V Harmonics Alarm Menu

Alarm relay:

Refer to 3.2.1.1.8.2 V - Alarm relay.

THDV High Limit:

This is used for entering high limit value of total harmonic distortion in the voltage. In order to set a THDV alarm, user shall enter a number higher than zero as THDV high limit. If zero is entered as the high limit value, THDV parameter is turned off for alarms.

It may be selected between 0.0 and 100.0 (For the usage of Virtual Keyboard,

[See 3.1.4 Example](#)).

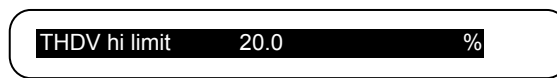

Fig. 3-60 THDV High Limit Setting

V3 --- V21 high limit:

This is used for entering high limit value of “3rd”, “5th” ... “21st” harmonic distortion in the voltage. In order to set a V3, V5 – V21 harmonic alarm, user shall enter a number higher than zero as high limit. If zero is entered as the high limit value, V3, V5 – V21 parameters are turned off for alarms.

It may be selected between 0.0 and 100.0. (For the usage of RAPIDUS Virtual Keyboard, [See 3.1.4 Example](#))

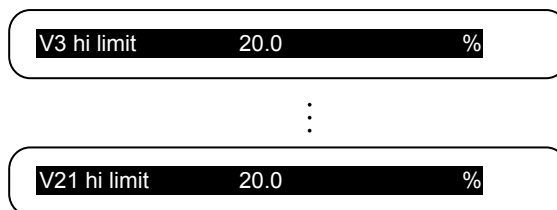

Fig. 3-61 V3-V21 Harmonics High Limit Setting

Delay:

Refer to 3.2.1.2.8.2 V – Delay.

3.2.1.2.8.12 I Harmonics Alarm Menu

Settings for the “I harmonics” alarms are the same for the settings for “V harmonics”.

3.2.1.2.8.13 Temperature Alarm Menu

This sub-menu is used for temperature alarm settings. Settings are the same for the settings for Alarm->V menu. (Temperature low and high limit values: It may be selected between -20.0 and 55.0°C).



If low limit and high limit values entered are the same, RAPIDUS does not give an alarm.

Settings->Setup->Alarm->Current

Alarm relay	Relay1	
Low limit	0.0	A
High limit	0.0	A
Delay	0.0	sec.
Hysteresis	0.0	%

Fig. 3-62 No Alarm Time Condition



If low limit entered is higher than the high limit, "Invalid limits! Please check" message is displayed on RAPIDUS screen.

Settings->Setup->Alarm->Current

Alarm relay	Relay1	
Low limit	0.0	A
High limit	0.0	A
Delay	0.0	sec.
Hysteresis	0.0	%

Invalid limits!
Please check.

X OK

Fig. 3-63 Invalid Limit

3.2.1.2.9 Clear Menu

Sub menus are displayed when you press OK when the Clear option selected. User shall select the tab to be cleared with up and down arrows and press "OK". Relevant clearing operation is performed if you press OK when "Are you sure?" message is displayed on the screen; and it returns back without clearing when you press X.

Energy and demand values are cleared. Learned connections are returned back to factory presets.

All tab performs all of the three operations above.

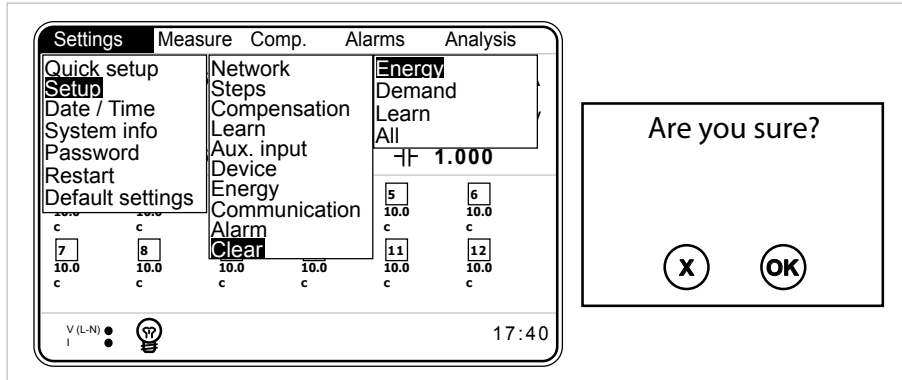

Fig. 3-64 Clear Menu

Assume that for a RAPIDUS used for some time, “Measure->Energy->Imp. Active” sub menu is like the one in Fig. 3-65.

Measure->Energy->Imp. active		
index	267500.1	kWh
Curr. hour	0.5	kWh
Prev. hour	0.6	kWh
Curr. day	21.3	kWh
Prev. day	22.6	kWh
Curr. month	598.4	kWh
Prev. month	439.5	kWh

Fig. 3-65 Before Clearing

After the clearing operation is completed, “Measure->Energy->Imp. Active” sub menu shall be like the one in Fig. 3-65.

Measure->Energy->Imp. active		
index	0.0	kWh
Curr. hour	0.0	kWh
Prev. hour	0.0	kWh
Curr. day	0.0	kWh
Prev. day	0.0	kWh
Curr. month	0.0	kWh
Prev. month	0.0	kWh

Fig. 3-66 After Clearing

After the clearing operation, a number different than zero may be seen for index parameters. This number is the initial value entered by the user for the relevant index parameter.

For example, assume that initial value for "Setup->Energy->T1 kWh" is entered as 7500 kWh. Then, after the clearing operation is completed, "Counters->Rate 1->Imp. Active->Index" value shall be 7500 kWh (See Fig. 3-67)

Measure->Energy->Imp. active		
Index	7500.0	kWh
Curr. hour	0.0	kWh
Prev. hour	0.0	kWh
Curr. day	0.0	kWh
Prev. day	0.0	kWh
Curr. month	0.0	kWh
Prev. month	0.0	kWh

Fig. 3-67 Initial Value Entered After Clearing

3.2.1.3 Date/Time Menu

Date/Time is set in this menu. (For RAPIDUS Date/Time Setting, See 3.1.2 Example).

Settings->Date / Time	
Time	18 : 49 : 30
Date	30 August 2014

Fig. 3-68 Date/Time Menu

3.2.1.4 System Info Menu

No setting is performed in this menu, it is just for informational purposes.

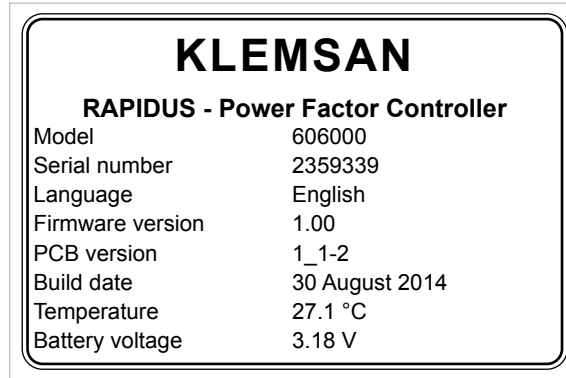

Fig. 3-69 System Info

Temperature and battery voltage values may be read via RS485.

3.2.1.5 Password Menu

If no password is entered, only Date/Time, System Info and Password tabs shall be active under settings menu. You shall enter a password in order to activate the other tabs.

“Login success” shall be displayed if the password entered is correct; and “Password mismatch” message shall be displayed if it is incorrect. (For the usage of RAPIDUS Virtual Keyboard, Refer to 3.1.4 Example).

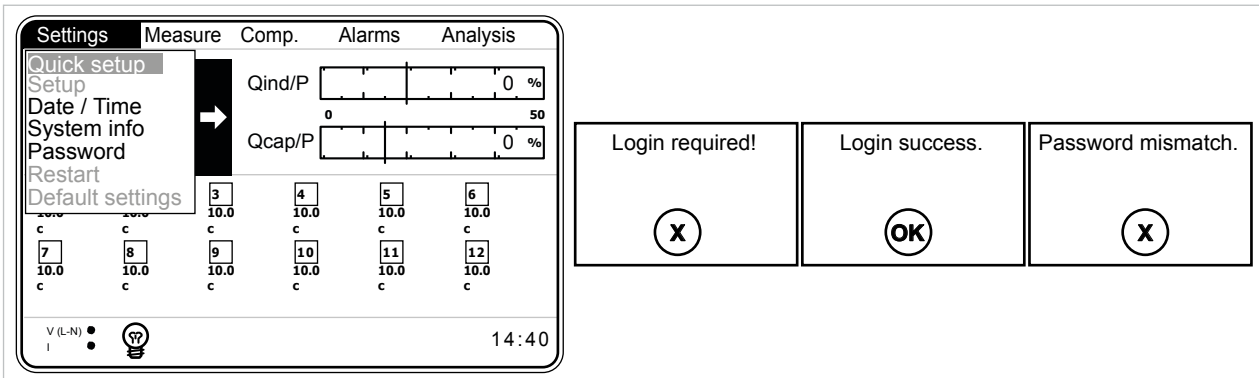

Fig. 3-70 Password

3.2.1.6 Restart

This is used for restarting RAPIDUS. “Are you sure?” message shall be displayed if you press OK when the Restart tab is highlighted. RAPIDUS is restarted by pressing OK again.

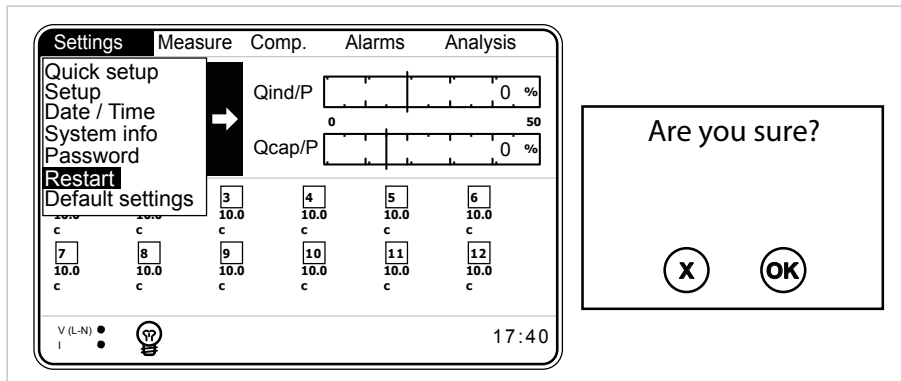

Fig. 3-71 RAPIDUS Restart

3.2.1.7 Default Settings

Default settings menu is used to return back to factory settings. After this operation, all settings other than date and time are returned back to factory settings.

Note: Index values are not reset after this operation.

NOTE: Index values are not reset after this operation.

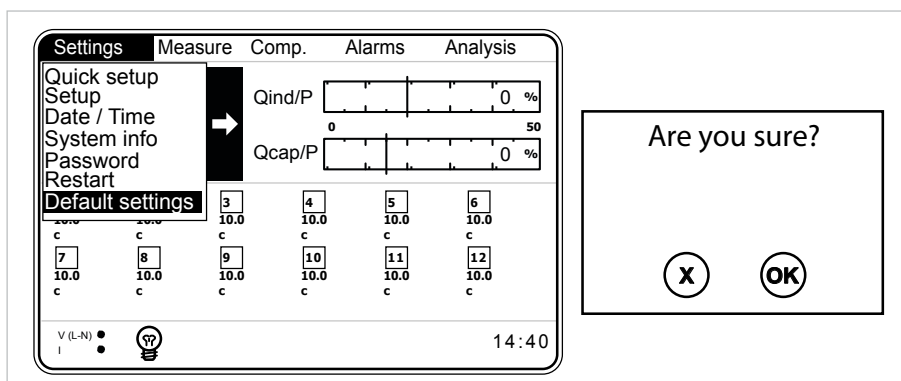

Fig. 3-72 Default Settings

3.2.2 Measure Menu

Sub-menus below are available under the measurements menu. User shall select the desired tab with up and down arrows and press "OK".

- Instantaneous
- Energy
- Demand
- Harmonics

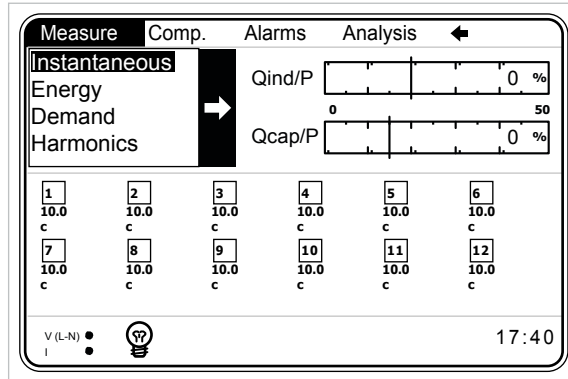

Fig. 3-73 Measure Menu

3.2.2.1 Instantaneous Menu

Instantaneous measurement values are available in this menu. Page in fig. 3-74 shall be displayed when OK is pressed while Measure menu, Instantaneous tab is highlighted. Instantaneous measurement parameters listed below are monitored using the right and left arrow keys.

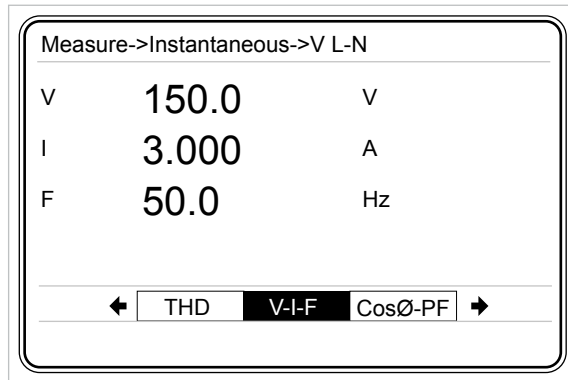

Fig. 3-74 Instantaneous Menu

- Voltage (V) values (as per the Phase to Neutral or Phase to Phase connection)
- Current (I) value
- Frequency (F) values
- CosØ value of the system
- Power factor of the system (PF)
- Total active power (P) value
- Total reactive power (Q) value
- Total apparent power (S) value
- Total THDV value
- Total THDI value

3.2.2.2 Energy Menu

This menu includes

- Imported active
- Exported active
- Inductive reactive
- Capacitive reactive

energy values.



When an energy meter reaches the value "50000000.0 Mega", it will start to count from "0.0".

3.2.2.2.1 Imp. Active Menu (Imported Active Energy Menu)

Imported active energy values are displayed.

Measure->Energy->Imp. active		
Index	0.0	kWh
Curr. hour	0.0	kWh
Prev. hour	0.0	kWh
Curr. day	0.0	kWh
Prev. day	0.0	kWh
Curr. month	0.0	kWh
Prev. month	0.0	kWh

Fig. 3-75 Imp. Active Energy Page

Index

is the imported active energy value from the time when the energy values are cleared to this moment.

Curr. hour

is the imported active energy value from the start of the hour to this moment.

Prev. hour

is the active energy value imported during the previous hour.

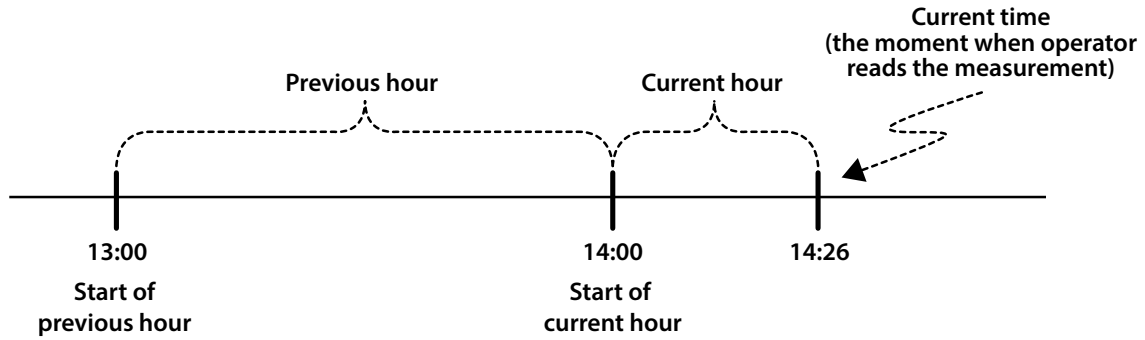

Fig. 3-76 Hour Start Example

Curr. day

is the imported active energy value from the starting hour of the day to this moment.

Prev. day

is the active energy value imported during the previous day.

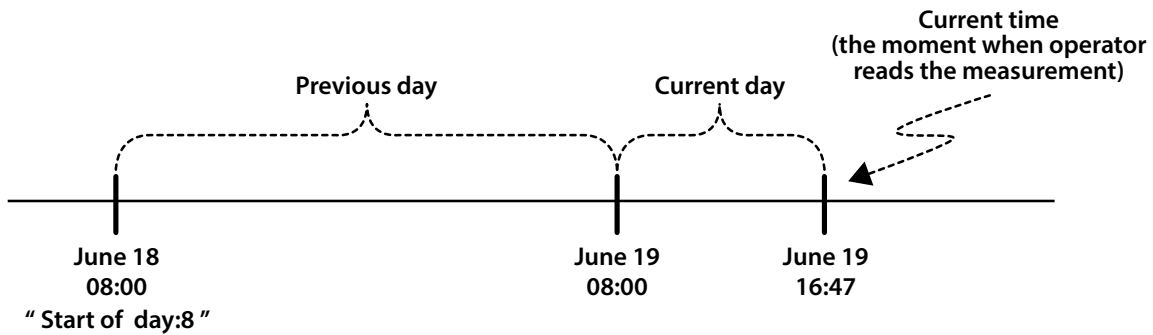

Fig. 3-77 Example for Start of Day

Curr. month

is the imported active energy value from the starting day of the month to this moment.

Prev. month

is the active energy value imported during the previous month.

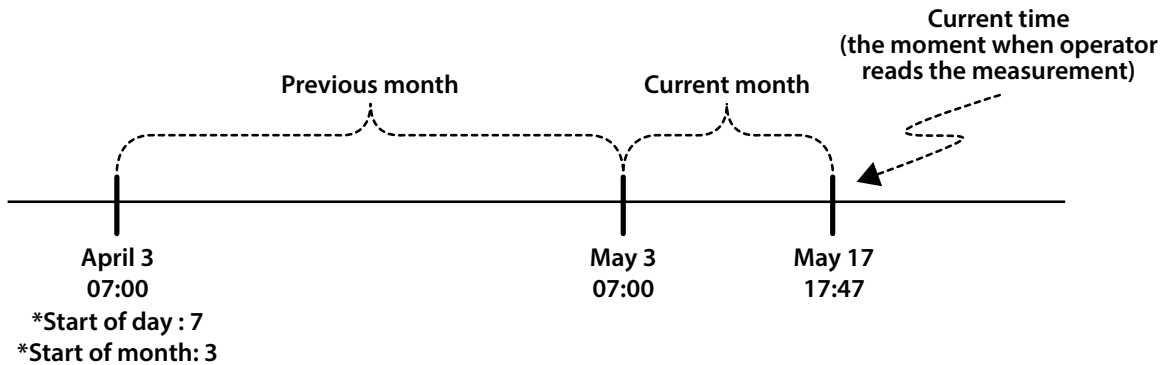

Fig. 3-78 Example for Start of Month

Settings for “start of day” and “start of month” parameters which are important for the usage of energy menu page are performed on “Settings->Setup->Energy” menu.

Example:

Assume that start of the day time is assigned as “0”. Then, when the system clock shows 00:00, the value in the “Curr. day” tab shall be recorded in the “prev. day” tab. “Curr. day” shall be reset and starts to count from zero.

Example:

Assume that start of the month day is assigned as “1” and start of the day time is assigned as “0”.

Then, when day of the moth is 1, and hour is 00:00, the value in the “Curr. month” tab shall be recorded in the “prev. month” tab. “Curr. month” shall be reset and starts to count from zero.

3.2.2.2.2 Exp. Active Menu (Exported Active Energy Menu)

The explanations for “Exp. active” menu are the same as 3.2.2.2.1 (Measure->Energy->Imp. Active) energy menu.

3.2.2.2.3 Ind. Reactive Menu (Inductive Reactive Energy Menu)

The explanations for “Ind. reactive” menu are the same as 3.2.2.2.1 (Measure->Energy->Imp. Active) energy menu.

3.2.2.2.4 Cap. Reactive Menu (Capacitive Reactive Energy Menu)

The explanations for “Cap. reactive” menu are the same as 3.2.2.2.1 (Measure->Energy->Imp. Active) energy menu.

3.2.2.3 Demand Menu

Highest values of the averages occurred in the currents and powers during the set demand period are displayed on the demand menu. Demand values are recorded with time information. On the demand sub menus, current and total power values are shown for the measured phase.

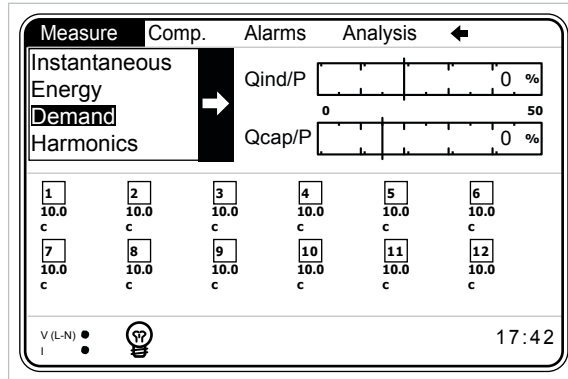
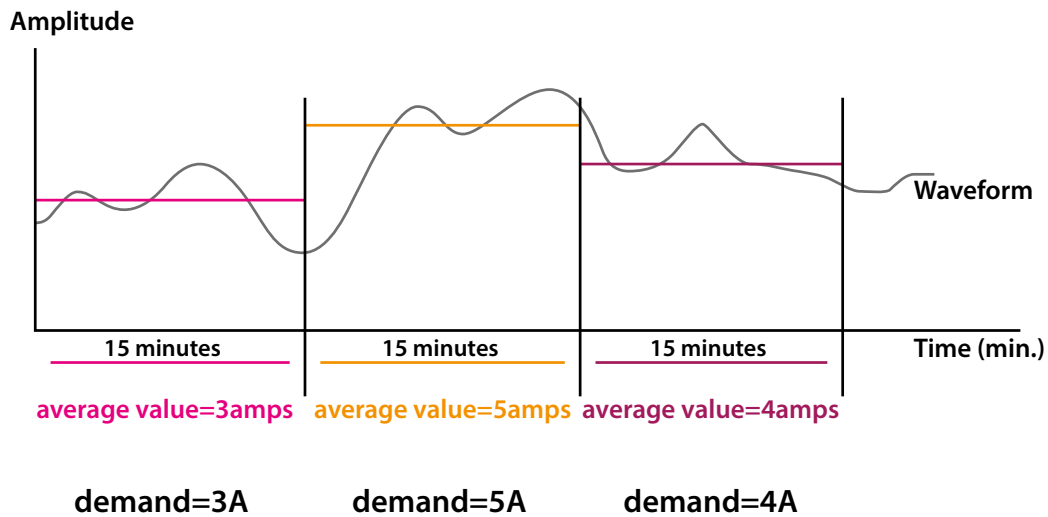

Fig. 3-79 Demand Menu

Example:

Current signal averages and demand value for 15 minutes demand period are shown in the following graphic.



demand period=15 minutes

Fig. 3-80 Demand Example

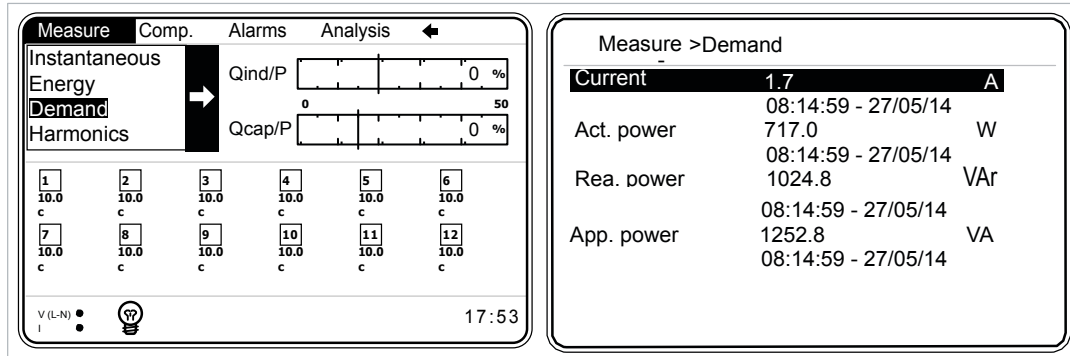

Fig. 3-81 Current Menu

Example:

Assume that the demand period is entered as 15 minutes and current value demand value and time are read as 5.0 A 02:44:59 - 10/10/13. Then, the description for the value read is as follows:

On October 10th, 2013, at 02:29:59 and 02:44:59 period, demand value is 5.0 A

Example:

Demand periods when the demand period is set as 15 minutes when system clock is 15:07:00 are shown below:

- 05:07:00 - 15:14:59 = 1st demand period
- 15:14:59 - 15:29:59 = 2nd demand period
- 15:29:59 - 15:44:59 = 3rd demand period
- 15:44:59 - 15:59:59 = 4th demand period
- 15:59:59 - 16:14:59 = 5th demand period

⋮

3.2.2.4 Harmonics Menu

RAPIDUS measures/calculates current and voltage harmonics up to 51st level. Current and voltage harmonics are displayed both in tabular and graphic form.

3.2.2.4.1 Table Menu

Current and voltage harmonics pertaining to each phase are displayed in tabular form in this menu (See Fig. 3-82). User may navigate between tables by pressing right and left arrows.

There are 2 table pages. V, I.

Measure->Harmonics->V %					
	1	2	3	4	5
1-5	90.55	0.01	30.03	0.00	29.98
6-10	0.00	0.00	0.01	0.01	0.01
11-15	0.02	0.01	0.00	0.02	0.01
16-20	0.02	0.02	0.01	0.00	0.00
21-25	0.01	0.02	0.02	0.01	0.01
26-30	0.01	0.01	0.02	0.01	0.01
31-35	0.01	0.01	0.01	0.00	0.00
36-40	0.02	0.01	0.01	0.02	0.01
41-45	0.01	0.00	0.01	0.01	0.01
46-50	0.02	0.01	0.00	0.01	0.01

← I % V % I % →

Fig. 3-82 Harmonics Table Menu

3.2.2.4.2 Graphic Menu

Current and voltage harmonics pertaining to each phase are displayed in graphic form in this menu (See Fig. 3-83). User may navigate between current-voltage graphics by pressing right and left arrows. There are 2 graphic pages: V, I.

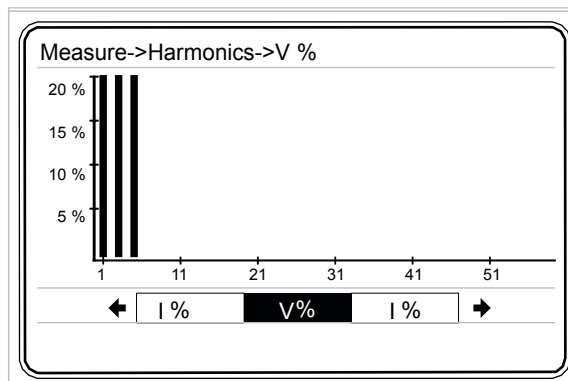

Fig. 3-83 Graphic Menu

3.2.3 Comp. (Compensation) Menu

Sub menus shown in Fig. 3-83 are available.

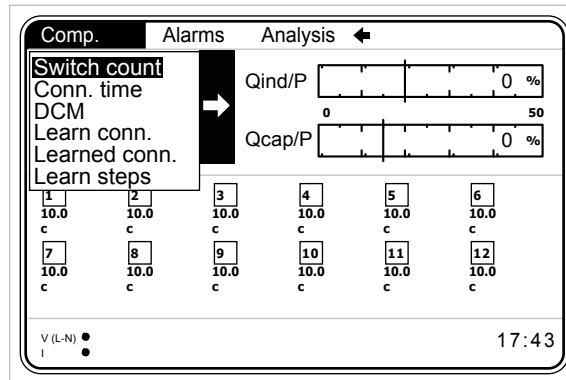
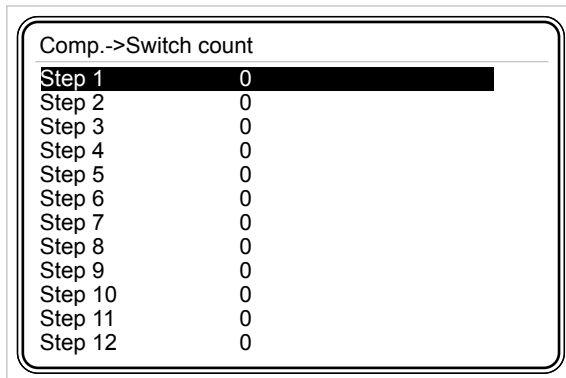

Fig. 3-84 Comp. Menu

3.2.3.1 Switch Count Menu

This menu displays how many times RAPIDUS activated each step.

In order to clear/change switching counts, highlight the desired step and press OK. Switch count is set between 0 and 10000. (For the usage of Virtual Keyboard, [See 3.1.4 Example](#)).



NOTE: There are two "Switch Count" submenus for RAPIDUS 212R. Operator can assign 1st, 2nd, ... and 12th step powers in "Switch Count 1" Submenu. Operator can assign 13th, 14th, ...and 24th step powers in "Switch Count 2" Submenu.

Fig. 3-85 Switch Count

3.2.3.2 Conn. Time Menu

Connection times of the steps are displayed.

In order to clear/change connection times, highlight the desired step and press OK. Conn. time is set between 0 and 1000000 (For the usage of Virtual Keyboard, [See 3.1.4 Example](#)).

Comp.->Conn. time		
Step 1	0	min
Step 2	0	min
Step 3	0	min
Step 4	0	min
Step 5	0	min
Step 6	0	min
Step 7	0	min
Step 8	0	min
Step 9	0	min
Step 10	0	min
Step 11	0	min
Step 12	0	min

NOTE: There are two "Conn. Time" submenus for RAPIDUS 212R. Operator can assign 1st, 2nd, ... and 12th step powers in "Conn. Time 1" Submenu. Operator can assign 13th, 14th, ...and 24th step powers in "Conn. Time 2" Submenu.

Fig. 3-86 Conn. Time

3.2.3.3 DCM (Dynamic Capacitor Monitoring)

Step values learned by dynamic monitoring can be followed from this menu. These are observed after a certain amount of time due to the effects and nature of DCM algorithm.

There is no compensation program with a prerequisite for DCM. DCM shall estimate step powers in each compensation program.

First estimation results require at least 128x8 compensation switching. Estimation values shall be updated at every 128 compensation switching after that. Previous estimation power is the entered or learned step power values.

NOTE: DCM(Dynamic Capacitor Monitoring) feature isn't available in RAPIDUS 212R

3.2.3.4 Learn Conn. Menu

Connections of current and voltage measurement inputs are learned.

RAPIDUS learns the connections by activating a 3-phase capacitor. Relevant capacitor is determined with the "Step number" tab on the 'Quick Setup' or 'Settings->Setup->Learn->Learn Conn.' menu.

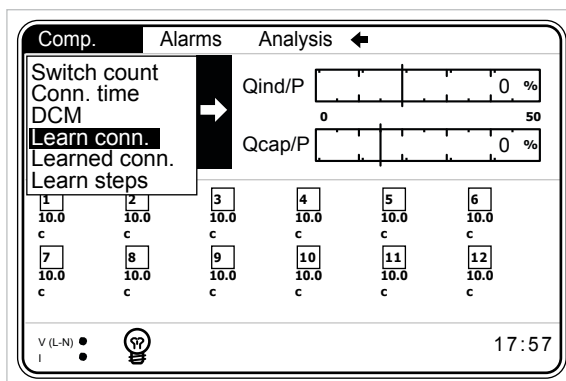

Fig. 3-87 Learn Conn.



On the "Step number" setting, the step number that the capacitor with the highest power value is connected shall be entered.

3.2.3.5 Learned Conn. Menu

Connections learned by RAPIDUS are displayed.

Comp..->Learned conn.

Learn success.

	L3-N	N-L3	L1-N	N-L1	L2-N	N-L2
k1-l1	240	60	0	180	120	300
l1-k1	60	240	180	10	300	120
k2-l2	120	300	240	60	0	180
l2-k2	300	120	60	240	180	0
k3-l3	0	180	120	300	240	60
l3-k3	180	0	300	120	60	240

Fig. 3-88 Learned Conn.

3.2.3.6 Learn Steps Menu

RAPIDUS learns the power and type of capacitors or shunt reactors connected to its steps by activating them in order.

The screenshot shows two panels of the control interface. The left panel displays the 'Comp.' menu with options: Switch count, Conn. time, DCM, Learn conn., Learned conn., and **Learn steps**. Below the menu is a grid of 12 capacitor status indicators, each showing a step number (3-12) and a value of 10.0. The right panel shows the 'Settings' menu with 'Measure Comp.' selected, displaying 'Learning step 1...' and a grid of 12 capacitor status indicators, each showing a step number (1-12) and a value of 10.0. Both panels show a voltage indicator 'V (L-N)' and a time display '17:58'.

Fig. 3-89 Learn Steps



No load (current amplitude and $\cos\phi$) changes shall occur in the system to ensure that step powers are learned correctly. Otherwise, RAPIDUS may learn step powers and step types incorrectly.

3.2.4 Alarms Menu

RAPIDUS alarms may be monitored from alarms menu. Sub menus are Phase, Step and Other.

A total of 50 alarm conditions with their times are recorded on the RAPIDUS MODBUS table. When the number of alarm conditions exceed 50, last occurring alarm conditions is written over the 1st alarm

On the MODBUS table, the descriptions for the variables related with the alarm conditions are as follows:

Alarm Timestamp : Carries alarm time information. It has 32 bit int. data structure.

Alarm Description : This is the bit number on the alarm tags. Thus, user may match the relevant bit on the alarm tag and the alarm. Refer to the example.

Alarm Status : Indicates alarm entry or alarm exit status. Both alarm entry and alarm exit are events for RAPIDUS. Both are recorded in MODBUS table.

1 -> Alarm entry

0 -> Alarm exit

Alarm Value : Current value of the parameter related with the alarm

Example:

Assume 100 VAC is entered as the low limit value for and the voltage has gone under 100VAC in the system. In this case,

Alarm Description is the index number of the relevant alarm bit in the alarm tags. Thus, for the condition above, "alarm description value" shall be 3.

Briefly, you can use the number under this heading as an index in the alarm tags to reach the description of alarm. Moreover, user matches the alarm and alarm tag.

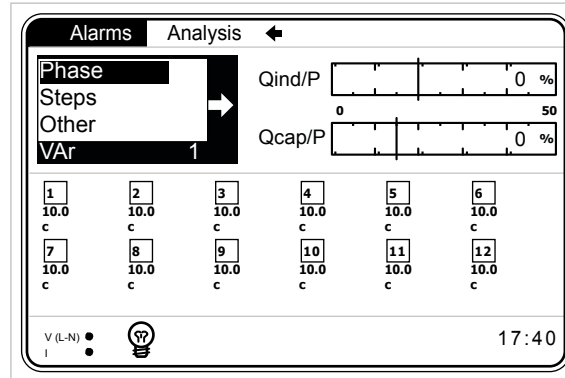

Fig. 3-90 Alarms Menu

3.2.4.1 Phase Menu

Statuses of alarms pertaining to 1st phase are shown in Phase menu.

“Normal” → NO Alarm

“Alarm” → Alarm AVAILABLE

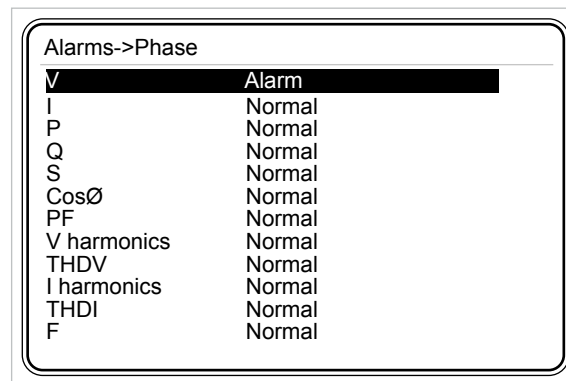

Fig. 3-91 Phase Menu

Following alarm statuses are monitored in Phase menu.

- V (Phase to Neutral voltage or Phase to Phase voltage according to the selected connection)
- I (current)
- P (active power)
- Q (reactive power)
- S (apparent power)
- CosØ
- PF (power factor)
- V harmonics (up to 21st voltage harmonics)
- THDV voltage (total harmonics distortion in the voltage)
- I harmonics (up to 21st current harmonics)
- THDI (total harmonics distortion in the current)
- F (frequency)

3.2.4.2 Step Menu

Descriptions of Normal and Alarm warnings are the same as Phase menu in “Step” menu. RAPIDUS gives an alarm when any of the steps used in compensation gets lower than the value calculated with the “low limit” setting (alarm limit).

Alarms->Steps	
Step 1	Normal
Step 2	Normal
Step 3	Normal
Step 4	Normal
Step 5	Normal
Step 6	Normal
Step 7	Normal
Step 8	Normal
Step 9	Normal
Step 10	Normal
Step 11	Normal
Step 12	Normal

Fig. 3-92 Step Menu

3.2.4.3 Other Menu

Descriptions of Normal and Alarm warnings are the same as Phase menu in “Other” menu.

Alarms->Other	
Under comp.	Normal
Over comp.	Normal
Ind. energy	Alarm
Cap. energy	Alarm
Temperature	Normal
Battery	Normal

Fig. 3-93 Other Menu

Following alarm statuses are observed in “Other” menu.

- Under comp.
- Over comp.
- Ind. energy
- Cap. energy
- Temperature
- Battery

When the battery voltage is less than 1.9V, RAPIDUS gives a battery alarm. When RAPIDUS gives a battery alarm, please contact the authorized dealer you have purchased the device (or nearest authorized dealer).

3.2.5 Analysis Menu

This menu contains sub menus shown in Fig. 3-94.

Analysis menu parameters can be read from MODBUS table. (Operator can find the related modbus table in CD-ROM).

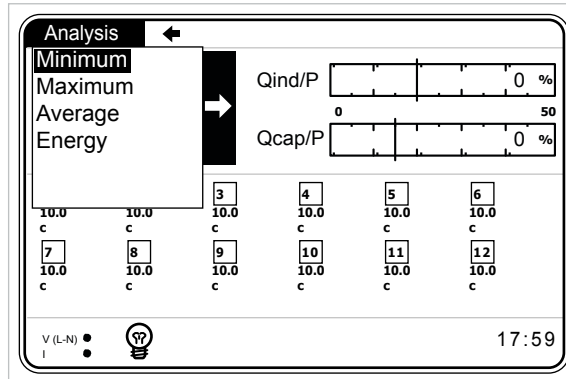

Fig. 3-94 Analysis Menu



Analysis menu parameters are not stored in nonvolatile memory. Therefore, all parameters pertaining to analysis menu are reset when the device is reset.

3.2.5.1 Minimum Menu

This menu includes hourly, daily and monthly minimum values.

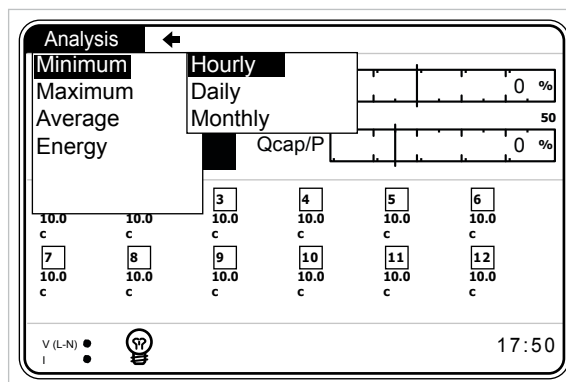

Fig. 3-95 Minimum Menu

3.2.5.1.1 Hourly Menu

This menu includes minimum 'instantaneous' values measured from the start of the hour to current time.

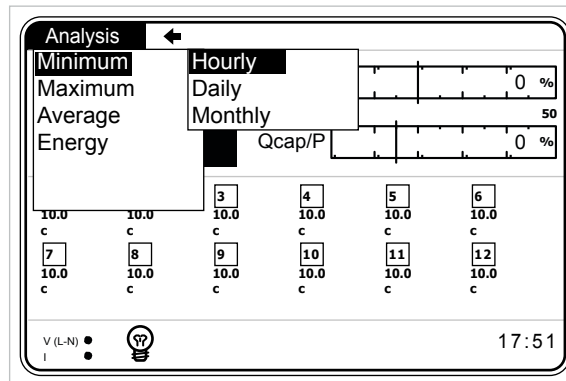

Fig. 3-96 Hourly Menu

3.2.5.1.1.1 Phase Menu

Voltage (V), current (I), active power (P), reactive power (Q), apparent power (S), $\cos\phi$, power factor (PF) and frequency (F) values are displayed.

3.2.5.1.2 Daily Menu

This menu includes minimum “instantaneous” values measured from the starting hour of the day (See to 3.2.1.2.6.1) to current time. Descriptions of sub menus are the same as the hourly menu.

3.2.5.1.3 Monthly Menu

This menu includes minimum “instantaneous” values measured from the starting day of the month (See to 3.2.1.2.6.2) and starting hour of the day (See to 3.2.1.2.6.1) to current time. Descriptions of sub menus are the same as the hourly menu.

3.2.5.2 Maximum Menu

Sub menus and descriptions of the sub menus of the “Maximum” menu are the same as “Minimum” menu. Values measured in “Maximum” menu are also “instantaneous” maximum values.

3.2.5.3 Average Menu

Sub menus and descriptions of the sub menus of the “Average” menu are the same as “Maximum” menu. “Average” menu displays the “average” values taken in hourly, daily and monthly periods.

3.2.5.4 Energy Menu

This menu includes hourly, daily and monthly counter values.

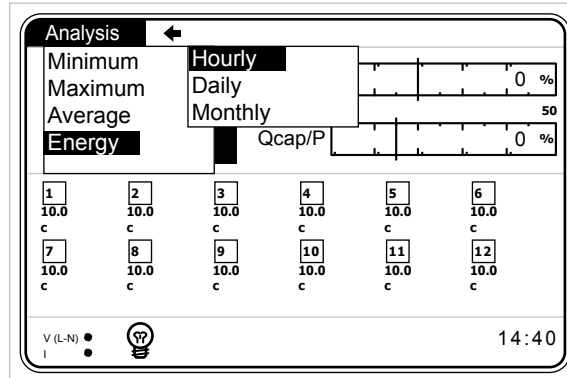

Fig. 3-97 Energy Menu

3.2.5.4.1 Hourly Menu

This menu includes counter values measured from the start of the hour to current time. kWh (imp. active), kWh E. (exp. active), kVARh I (inductive reactive), kVARh C. (capacitive reactive) counter values are displayed.

3.2.5.4.2 Daily Menu

This menu includes counter values measured from the starting hour of the day (See 3.2.1.2.6.1) to current time.

kWh (imp. active), kWh E. (exp. active), kVARh I (inductive reactive), kVARh C. (capacitive reactive) counter values are displayed.

3.2.5.4.3 Monthly Menu

This menu includes counter values measured from the starting day of the month (See 3.2.1.2.6.2) and starting hour of the day (See 3.2.1.2.6.1) to current time.

kWh (imp. active), kWh E. (exp. active), kVARh I (inductive reactive), kVARh C. (capacitive reactive) counter values are displayed.



RAPIDUS

Power Factor
Controller

**SECTION 4
MODBUS
PROTOCOL**

SECTION 4 MODBUS PROTOCOL

4.1 RS485 Wiring Diagram

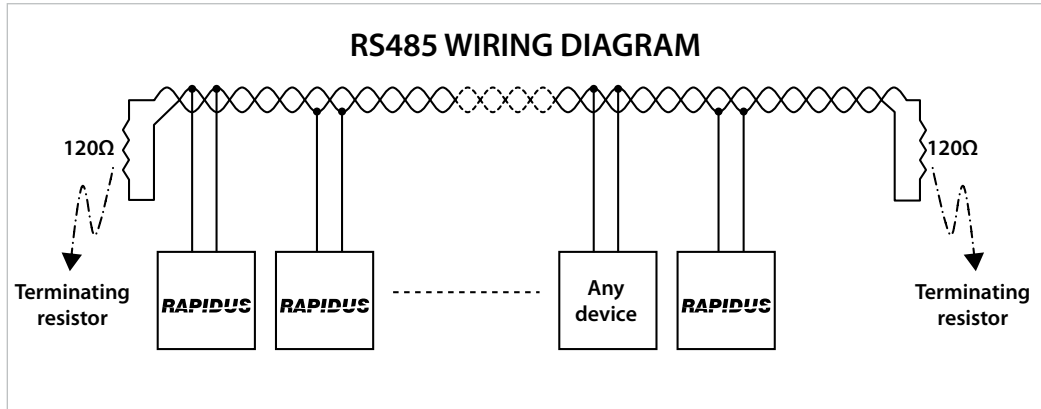

Figure 4-1 RS485 Wiring Diagram

4.2 Computer Connection

RAPIDUS can communicate with PCs via USB-RS85 or RS232-RS485 converters.

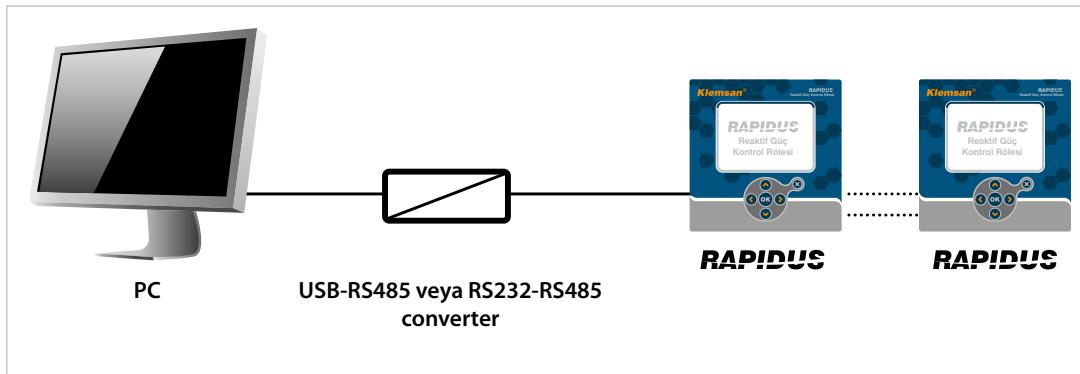

Figure 4-2 RS485 PC Connection

4.3 and Data Types of MODBUS-RTU Protocol

RAPIDUS, implements modbus RTU protocol. Modbus RTU message format is as follows.

Table 4-1 Message Format

Start	Address	Function	Data	CRC	End
≥ 3.5 byte	1 byte	1 byte	0-252 byte	2 byte	≥ 3.5 byte

There should be a time gap, which is at least 3.5 characters wide, between RTU messages.

For instance, when client device requests any information, server device should reply after at least a 3.5 character wide time gap. Following the response of the server, client

device should wait 3.5 characters long period, before requesting information again.

Data types used in RAPIDUS are as follows.

Table 4-2 int (32 bit) data type

b31 (Bit 31)	-----	b0 (Bit 0)
MSB (Most Significant Bit)	-----	LSB (Least Significant Bit)

int:

32-bit integer value. Byte order starts from the lowest byte address as b0, b1, b2 and so on.

float:

It is a 32-bit floating-point number in IEEE 754 standard.

string:

Character array in ASCII standard. It is only used for RAPIDUS device name and RAPIDUS configuration name variables.

4.4 Implemented functions for MODBUS-RTU Protocol

Table 4-3 Implemented functions for MODBUS RTU Protocol

Function Name	Function Code
Read Holding Registers	03H (decimal value 3)
Write Single Register	06H (decimal value 6)
Write Multiple Registers	10H (decimal value 16)
Read file record	14H (decimal value 20)

4.5 Data and Setting Parameters for RAPIDUS

4.5.1 Measured and Calculated Data



Calculated and measured data are “read-only” values.

Operator/programmer can reach all measured and calculated data via MODBUS RTU protocol. Starting address for measured and calculated data is 0.

Example:

Three phase average voltage is read via the 0th and 1th registers (16 bits + 16 bits = 32 bit).

PC (or PLC) Request

Slave ID	01h
Function code	03h
Register address – high	00h
Register address – low	00h
Number of registers– high	00h
Number of registers – low	02h
CRC high	C4h
CRC low	0Bh

RAPIDUS Response

Slave ID	01h
Function code	03h
Byte counts	04h
Register value - high (0)	43h
Register value - low (0)	5DH
Register value - high (1)	36H
Register value - low (1)	E0h
CRC high	68h
CRC low	4Dh

The “Byte counts” information of RAPIDUS response is two times “Number of registers” value of “PC request” (1 register = 2 bytes).

Register value high(0) and low(0) together with register value high(1) and low(1) constitute a 32-bit value. This value should be converted (typecasted) to a float value. The float value of the mentioned 32-bit variable is 221.2143555.

4.5.1.1 Readable Data for RAPIDUS 211R-E

Table 4-4 Readable Data(RAPIDUS 211R-E)

Address	Parameter	Description	R/W Descript.	Unit	Data Type
0	V	Voltage	RO	V	32 bit float
2	I	Current	RO	A	32 bit float
4	P	Total active power	RO	W	32 bit float
6	Q	Total reactive power	RO	VAr	32 bit float
8	S	Total apparent power	RO	VA	32 bit float
10	CosØ	System CosØ	RO	-	32 bit float
12	PF	System PF	RO	-	32 bit float
14	F	System Frequency	RO	Hz	32 bit float
16	THDV	Total har. distortion of voltage	RO	%	32 bit float
18	THDI	Total har. distortion of current	RO	%	32 bit float
20	V Harmonic 1	Voltage 1st harmonics	RO	%	32 bit float
22	V Harmonic 3	Voltage 3rd harmonics	RO	%	32 bit float
24	V Harmonic 5	Voltage 5th harmonics	RO	%	32 bit float
26	V Harmonic 7	Voltage 7th harmonics	RO	%	32 bit float
28	V Harmonic 9	Voltage 9th harmonics	RO	%	32 bit float
30	V Harmonic 11	Voltage 11th harmonics	RO	%	32 bit float
32	V Harmonic 13	Voltage 13th harmonics	RO	%	32 bit float
34	V Harmonic 15	Voltage 15th harmonics	RO	%	32 bit float
36	V Harmonic 17	Voltage 17th harmonics	RO	%	32 bit float
38	V Harmonic 19	Voltage 19th harmonics	RO	%	32 bit float
40	V Harmonic 21	Voltage 21st harmonics	RO	%	32 bit float

Address	Parameter	Description	R/W Descript.	Unit	Data Type
42	V Harmonic 23	Voltage 23rd harmonics	RO	%	32 bit float
44	V Harmonic 25	Voltage 25th harmonics	RO	%	32 bit float
46	V Harmonic 27	Voltage 27th harmonics	RO	%	32 bit float
48	V Harmonic 29	Voltage 29th harmonics	RO	%	32 bit float
50	V Harmonic 31	Voltage 31st harmonics	RO	%	32 bit float
52	V Harmonic 33	Voltage 33rd harmonics	RO	%	32 bit float
54	V Harmonic 35	Voltage 35th harmonics	RO	%	32 bit float
56	V Harmonic 37	Voltage 37th harmonics	RO	%	32 bit float
58	V Harmonic 39	Voltage 39th harmonics	RO	%	32 bit float
60	V Harmonic 41	Voltage 41th harmonics	RO	%	32 bit float
62	V Harmonic 43	Voltage 43rd harmonics	RO	%	32 bit float
64	V Harmonic 45	Voltage 45th harmonics	RO	%	32 bit float
66	V Harmonic 47	Voltage 47th harmonics	RO	%	32 bit float
68	V Harmonic 49	Voltage 49th harmonics	RO	%	32 bit float
70	V Harmonic 51	Voltage 51st harmonics	RO	%	32 bit float
72	I Harmonic 1	Current 1st harmonics	RO	%	32 bit float
74	I Harmonic 3	Voltage 3rd harmonics	RO	%	32 bit float
76	I Harmonic 5	Voltage 5th harmonics	RO	%	32 bit float
78	I Harmonic 7	Voltage 7th harmonics	RO	%	32 bit float
80	I Harmonic 9	Voltage 9th harmonics	RO	%	32 bit float
82	I Harmonic 11	Voltage 11th harmonics	RO	%	32 bit float
84	I Harmonic 13	Voltage 13th harmonics	RO	%	32 bit float
86	I Harmonic 15	Voltage 15th harmonics	RO	%	32 bit float
88	I Harmonic 17	Voltage 17th harmonics	RO	%	32 bit float
90	I Harmonic 19	Voltage 19th harmonics	RO	%	32 bit float
92	I Harmonic 21	Voltage 21st harmonics	RO	%	32 bit float
94	I Harmonic 23	Voltage 23rd harmonics	RO	%	32 bit float
96	I Harmonic 25	Voltage 25th harmonics	RO	%	32 bit float
98	I Harmonic 27	Voltage 27th harmonics	RO	%	32 bit float
100	I Harmonic 29	Voltage 29th harmonics	RO	%	32 bit float
102	I Harmonic 31	Voltage 31st harmonics	RO	%	32 bit float
104	I Harmonic 33	Voltage 33rd harmonics	RO	%	32 bit float
106	I Harmonic 35	Voltage 35th harmonics	RO	%	32 bit float
108	I Harmonic 37	Voltage 37th harmonics	RO	%	32 bit float
110	I Harmonic 39	Voltage 39th harmonics	RO	%	32 bit float
112	I Harmonic 41	Voltage 41th harmonics	RO	%	32 bit float
114	I Harmonic 43	Voltage 43rd harmonics	RO	%	32 bit float
116	I Harmonic 45	Voltage 45th harmonics	RO	%	32 bit float
118	I Harmonic 47	Voltage 47th harmonics	RO	%	32 bit float
120	I Harmonic 49	Voltage 49th harmonics	RO	%	32 bit float
122	I Harmonic 51	Voltage 51st harmonics	RO	%	32 bit float
Alarm					
124	Alarms 1	Alarm flag 1 (first 32 bit)	RO	-	32 bit int.
126	Alarms 2	Alarm flag 2 (second 32 bit)	RO	-	32 bit int.

Address	Parameter	Description	R/W Descript.	Unit	Data Type
Step					
128	Active step	Active step flags	RO	-	32 bit int.
130	Available step	Available step flags	RO	-	32 bit int.
132	Fixed step	Fixed step flags	RO	-	32 bit int.
134	S1 switching count	Step 1 switching count	RO	-	32 bit int.
136	S2 switching count	Step 2 switching count	RO	-	32 bit int.
138	S3 switching count	Step 3 switching count	RO	-	32 bit int.
140	S4 switching count	Step 4 switching count	RO	-	32 bit int.
142	S5 switching count	Step 5 switching count	RO	-	32 bit int.
144	S6 switching count	Step 6 switching count	RO	-	32 bit int.
146	S7 switching count	Step 7 switching count	RO	-	32 bit int.
148	S8 switching count	Step 8 switching count	RO	-	32 bit int.
150	S9 switching count	Step 9 switching count	RO	-	32 bit int.
152	S10 switching count	Step 10 switching count	RO	-	32 bit int.
154	S11 switching count	Step 11 switching count	RO	-	32 bit int.
156	S12 switching count	Step 12 switching count	RO	-	32 bit int.
158	S1 operation time	Step 1 operation time	RO	min.	32 bit int.
160	S2 operation time	Step 2 operation time	RO	min.	32 bit int.
162	S3 operation time	Step 3 operation time	RO	min.	32 bit int.
164	S4 operation time	Step 4 operation time	RO	min.	32 bit int.
166	S5 operation time	Step 5 operation time	RO	min.	32 bit int.
168	S6 operation time	Step 6 operation time	RO	min.	32 bit int.
170	S7 operation time	Step 7 operation time	RO	min.	32 bit int.
172	S8 operation time	Step 8 operation time	RO	min.	32 bit int.
174	S9 operation time	Step 9 operation time	RO	min.	32 bit int.
176	S10 operation time	Step 10 operation time	RO	min.	32 bit int.
178	S11 operation time	Step 11 operation time	RO	min.	32 bit int.
180	S12 operation time	Step 12 operation time	RO	min.	32 bit int.
Energy Meters (32 Bit)					
182	Imp. Act. Index	Import Active Index	RO	kWh	32 bit float
184	Imp. Act. Curr. Hour	Import Active Current Hour	RO	kWh	32 bit float
186	Imp. Act. Prev. Hour	Import Active Previous Hour	RO	kWh	32 bit float
188	Imp. Act. Curr. Day	Import. Active Current Day	RO	kWh	32 bit float
190	Imp. Act. Prev. Day	Import Active Previous Day	RO	kWh	32 bit float
192	Imp. Act. Curr. Month	Import Active Current Month	RO	kWh	32 bit float
194	Imp. Act. Prev. Month	Import Previous Month	RO	kWh	32 bit float
196	Exp. Act. Index	Export Active Index	RO	kWh	32 bit float
198	Exp. Act. Curr. Hour	Export Active Current Hour	RO	kWh	32 bit float
200	Exp. Act. Prev. Hour	Export Active Previous Hour	RO	kWh	32 bit float
202	Exp. Act. Curr. Day	Export Active Current Day	RO	kWh	32 bit float
204	Exp. Act. Prev. Day	Export Active Previous Day	RO	kWh	32 bit float
206	Exp. Act. Curr. Month	Export Active Current Month	RO	kWh	32 bit float
208	Exp. Act. Prev. Month	Export Active Previous Month	RO	kWh	32 bit float
210	Ind. React. Index	Inductive Reactive Index	RO	kVArh	32 bit float

Address	Parameter	Description	R/W Descript.	Unit	Data Type
212	Ind. React. Curr. Hour	Inductive Reactive Current Hour	RO	kVArh	32 bit float
214	Ind. React. Prev. Hour	Inductive Reactive Previous Hour	RO	kVArh	32 bit float
216	Ind. React. Curr. Day	Inductive Reactive Current Day	RO	kVArh	32 bit float
218	Ind. React. Prev. Day	Inductive Reactive Previous Day	RO	kVArh	32 bit float
220	Ind. React. Curr. Month	Inductive Reactive Current Month	RO	kVArh	32 bit float
222	Ind. React. Prev. Month	Inductive Reactive Previous Month	RO	kVArh	32 bit float
224	Cap. React. Index	Capacitive Reactive Index	RO	kVArh	32 bit float
226	Cap. React. Curr. Hour	Capacitive Reactive Current Hour	RO	kVArh	32 bit float
228	Cap. React. Prev. Hour	Capacitive Reactive Previous Hour	RO	kVArh	32 bit float
230	Cap. React. Curr. Day	Capacitive Reactive Current Day	RO	kVArh	32 bit float
232	Cap. React. Prev. Day	Capacitive Reactive Previous Day	RO	kVArh	32 bit float
234	Cap. React. Curr. Month	Capacitive Reactive Current Month	RO	kVArh	32 bit float
236	Cap. React. Prev. Month	Capacitive Reactive Previous Month	RO	kVArh	32 bit float
Demand					
238	P tot.	Total active power demand	RO	W	32 bit float
240	P tot. time	Total active power demand time	RO	-	32 bit unix time
242	I tot.	Total current demand	RO	A	32 bit float
244	I tot. time	Total current demand time	RO	-	32 bit unix time
246	Q tot.	Total reactive power demand	RO	VAr	32 bit float
248	Q tot. time	Total reactive power demand time	RO	-	32 bit unix time
250	S tot.	Total apperant power demand	RO	VA	32 bit float
252	S tot. time	Total apperant power demand time	RO	-	32 bit unix time
Other					
254	Temp.	Temperature Value	RO	°C	32 bit float
256	Battery voltage	-	RO	V	32 bit float
258	Time	System Date and Time	R/W	-	32 bit unix time
Alarm Status					
260	1 - Alarm Timestamp	1 - Alarm time	RO	-	32 bit unix time
262	1 - Alarm ID	1 - Alarm ID	RO	-	32 bit int.
264	1 - Alarm Status	1 - Alarm ON /Alarm OFF status	RO	-	32 bit int.
266	1 - Alarm Value	1 - Value of related alarm parameter	RO	-	32 bit float
268	2 - Alarm Timestamp	2 - Alarm time	RO	-	32 bit unix time
270	2 - Alarm ID	2 - Alarm ID	RO	-	32 bit int.
272	2 - Alarm Status	2 - Alarm ON /Alarm OFF status	RO	-	32 bit int.
274	2 - Alarm Value	2 - Value of related alarm parameter	RO	-	32 bit float
276	3 - Alarm Timestamp	3 - Alarm time	RO	-	32 bit unix time
278	3 - Alarm ID	3 - Alarm ID	RO	-	32 bit int.
280	3 - Alarm Status	3 - Alarm ON /Alarm OFF status	RO	-	32 bit int.
282	3 - Alarm Value	3 - Value of related alarm parameter	RO	-	32 bit float
284	4 - Alarm Timestamp	4 - Alarm time	RO	-	32 bit unix time
286	4 - Alarm ID	4 - Alarm ID	RO	-	32 bit int.

Address	Parameter	Description	R/W Descript.	Unit	Data Type
288	4 - Alarm Status	4 - Alarm ON /Alarm OFF status	RO	-	32 bit int.
290	4 - Alarm Value	4 - Value of related alarm parameter	RO	-	32 bit float
292	5 - Alarm Timestamp	5 - Alarm time	RO	-	32 bit unix time
294	5 - Alarm ID	5 - Alarm ID	RO	-	32 bit int.
296	5 - Alarm Status	5 - Alarm ON /Alarm OFF status	RO	-	32 bit int.
298	5 - Alarm Value	5 - Value of related alarm parameter	RO	-	32 bit float
300	6 - Alarm Timestamp	6 - Alarm time	RO	-	32 bit unix time
302	6 - Alarm ID	6 - Alarm ID	RO	-	32 bit int.
304	6 - Alarm Status	6 - Alarm ON /Alarm OFF status	RO	-	32 bit int.
306	6 - Alarm Value	6 - Value of related alarm parameter	RO	-	32 bit float
308	7 - Alarm Timestamp	7 - Alarm time	RO	-	32 bit unix time
310	7 - Alarm ID	7 - Alarm ID	RO	-	32 bit int.
312	7 - Alarm Status	7 - Alarm ON /Alarm OFF status	RO	-	32 bit int.
314	7 - Alarm Value	7 - Value of related alarm parameter	RO	-	32 bit float
316	8 - Alarm Timestamp	8 - Alarm time	RO	-	32 bit unix time
318	8 - Alarm ID	8 - Alarm ID	RO	-	32 bit int.
320	8 - Alarm Status	8 - Alarm ON /Alarm OFF status	RO	-	32 bit int.
322	8 - Alarm Value	8 - Value of related alarm parameter	RO	-	32 bit float
324	9 - Alarm Timestamp	9 - Alarm time	RO	-	32 bit unix time
326	9 - Alarm ID	9 - Alarm ID	RO	-	32 bit int.
328	9 - Alarm Status	9 - Alarm ON /Alarm OFF status	RO	-	32 bit int.
330	9 - Alarm Value	9 - Value of related alarm parameter	RO	-	32 bit float
332	10 - Alarm Timestamp	10 - Alarm time	RO	-	32 bit unix time
334	10 - Alarm ID	10 - Alarm ID	RO	-	32 bit int.
336	10 - Alarm Status	10 - Alarm ON /Alarm OFF status	RO	-	32 bit int.
338	10 - Alarm Value	10 - Value of related alarm parameter	RO	-	32 bit float
340	11 - Alarm Timestamp	11 - Alarm time	RO	-	32 bit unix time
342	11 - Alarm ID	11 - Alarm ID	RO	-	32 bit int.
344	11 - Alarm Status	11 - Alarm ON /Alarm OFF status	RO	-	32 bit int.
346	11 - Alarm Value	11 - Value of related alarm parameter	RO	-	32 bit float
348	12 - Alarm Timestamp	12 - Alarm time	RO	-	32 bit unix time
350	12 - Alarm ID	12 - Alarm ID	RO	-	32 bit int.
352	12 - Alarm Status	12 - Alarm ON /Alarm OFF status	RO	-	32 bit int.
354	12 - Alarm Value	12 - Value of related alarm parameter	RO	-	32 bit float
356	13 - Alarm Timestamp	13 - Alarm time	RO	-	32 bit unix time
358	13 - Alarm ID	13 - Alarm ID	RO	-	32 bit int.
360	13 - Alarm Status	13 - Alarm ON /Alarm OFF status	RO	-	32 bit int.
362	13 - Alarm Value	13 - Value of related alarm parameter	RO	-	32 bit float
364	14 - Alarm Timestamp	14 - Alarm time	RO	-	32 bit unix time
366	14 - Alarm ID	14 - Alarm ID	RO	-	32 bit int.
368	14 - Alarm Status	14 - Alarm ON /Alarm OFF status	RO	-	32 bit int.
370	14 - Alarm Value	14 - Value of related alarm parameter	RO	-	32 bit float
372	15 - Alarm Timestamp	15 - Alarm zaman değeri	RO	-	32 bit unix time
374	15 - Alarm ID	15 - Alarm ID	RO	-	32 bit int.

Address	Parameter	Description	R/W Descript.	Unit	Data Type
376	15 - Alarm Status	15 - Alarm ON /Alarm OFF status	RO	-	32 bit int.
378	15 - Alarm Value	15 - Value of related alarm parameter	RO	-	32 bit float
380	16 - Alarm Timestamp	16 - Alarm time	RO	-	32 bit unix time
382	16 - Alarm ID	16 - Alarm ID	RO	-	32 bit int.
384	16 - Alarm Status	16 - Alarm ON /Alarm OFF status	RO	-	32 bit int.
386	16 - Alarm Value	16 - Value of related alarm parameter	RO	-	32 bit float
388	17 - Alarm Timestamp	17 - Alarm time	RO	-	32 bit unix time
390	17 - Alarm ID	17 - Alarm ID	RO	-	32 bit int.
392	17 - Alarm Status	17 - Alarm ON /Alarm OFF status	RO	-	32 bit int.
394	17 - Alarm Value	17 - Value of related alarm parameter	RO	-	32 bit float
396	18 - Alarm Timestamp	18 - Alarm time	RO	-	32 bit unix time
398	18 - Alarm ID	18 - Alarm ID	RO	-	32 bit int.
398	18 - Alarm Status	18 - Alarm ON /Alarm OFF status	RO	-	32 bit int.
400	18 - Alarm Value	18 - Value of related alarm parameter	RO	-	32 bit float
402	19 - Alarm Timestamp	19 - Alarm time	RO	-	32 bit unix time
404	19 - Alarm ID	19 - Alarm ID	RO	-	32 bit int.
406	19 - Alarm Status	19 - Alarm ON /Alarm OFF status	RO	-	32 bit int.
408	19 - Alarm Value	19 - Value of related alarm parameter	RO	-	32 bit float
410	20 - Alarm Timestamp	20 - Alarm time	RO	-	32 bit unix time
412	20 - Alarm ID	20 - Alarm ID	RO	-	32 bit int.
414	20 - Alarm Status	20 - Alarm ON /Alarm OFF status	RO	-	32 bit int.
416	20 - Alarm Value	20 - Value of related alarm parameter	RO	-	32 bit float
418	21 - Alarm Timestamp	21 - Alarm time	RO	-	32 bit unix time
420	21 - Alarm ID	21 - Alarm ID	RO	-	32 bit int.
422	21 - Alarm Status	21 - Alarm ON /Alarm OFF status	RO	-	32 bit int.
424	21 - Alarm Value	21 - Value of related alarm parameter	RO	-	32 bit float
418	21 - Alarm Timestamp	21 - Alarm time	RO	-	32 bit unix time
420	21 - Alarm ID	21 - Alarm ID	RO	-	32 bit int.
422	21 - Alarm Status	21 - Alarm ON /Alarm OFF status	RO	-	32 bit int.
424	21 - Alarm Value	21 - Value of related alarm parameter	RO	-	32 bit float
426	22 - Alarm Timestamp	22 - Alarm time	RO	-	32 bit unix time
428	22 - Alarm ID	22 - Alarm ID	RO	-	32 bit int.
430	22 - Alarm Status	22 - Alarm ON /Alarm OFF status	RO	-	32 bit int.
432	22 - Alarm Value	22 - Value of related alarm parameter	RO	-	32 bit float
434	23 - Alarm Timestamp	23 - Alarm time	RO	-	32 bit unix time
436	23 - Alarm ID	23 - Alarm ID	RO	-	32 bit int.
438	23 - Alarm Status	23 - Alarm ON /Alarm OFF status	RO	-	32 bit int.
440	23 - Alarm Value	23 - Value of related alarm parameter	RO	-	32 bit float
442	24 - Alarm Timestamp	24 - Alarm time	RO	-	32 bit unix time
444	24 - Alarm ID	24 - Alarm ID	RO	-	32 bit int.
448	24 - Alarm Status	24 - Alarm ON /Alarm OFF status	RO	-	32 bit int.
450	24 - Alarm Value	24 - Value of related alarm parameter	RO	-	32 bit float
452	25 - Alarm Timestamp	25 - Alarm time	RO	-	32 bit unix time
454	25 - Alarm ID	25 - Alarm ID	RO	-	32 bit int.

Address	Parameter	Description	R/W Descript.	Unit	Data Type
456	25 - Alarm Status	25 - Alarm ON /Alarm OFF status	RO	-	32 bit int.
458	25 - Alarm Value	25 - Value of related alarm parameter	RO	-	32 bit float
460	26 - Alarm Timestamp	26 - Alarm time	RO	-	32 bit unix time
462	26 - Alarm ID	26 - Alarm ID	RO	-	32 bit int.
464	26 - Alarm Status	26 - Alarm ON /Alarm OFF status	RO	-	32 bit int.
466	26 - Alarm Value	26 - Value of related alarm parameter	RO	-	32 bit float
468	27 - Alarm Timestamp	27 - Alarm time	RO	-	32 bit unix time
470	27 - Alarm ID	27 - Alarm ID	RO	-	32 bit int.
472	27 - Alarm Status	27 - Alarm ON /Alarm OFF status	RO	-	32 bit int.
474	27 - Alarm Value	27 - Value of related alarm parameter	RO	-	32 bit float
476	28 - Alarm Timestamp	28 - Alarm time	RO	-	32 bit unix time
478	28 - Alarm ID	28 - Alarm ID	RO	-	32 bit int.
480	28 - Alarm Status	28 - Alarm ON /Alarm OFF status	RO	-	32 bit int.
482	28 - Alarm Value	28 - Value of related alarm parameter	RO	-	32 bit float
484	29 - Alarm Timestamp	29 - Alarm time	RO	-	32 bit unix time
486	29 - Alarm ID	29 - Alarm ID	RO	-	32 bit int.
488	29 - Alarm Status	29 - Alarm ON /Alarm OFF status	RO	-	32 bit int.
490	29 - Alarm Value	29 - Value of related alarm parameter	RO	-	32 bit float
492	30 - Alarm Timestamp	30 - Alarm time	RO	-	32 bit unix time
494	30 - Alarm ID	30 - Alarm ID	RO	-	32 bit int.
496	30 - Alarm Status	30 - Alarm ON /Alarm OFF status	RO	-	32 bit int.
498	30 - Alarm Value	30 - Value of related alarm parameter	RO	-	32 bit float
500	31 - Alarm Timestamp	31 - Alarm time	RO	-	32 bit unix time
502	31 - Alarm ID	31 - Alarm ID	RO	-	32 bit int.
504	31 - Alarm Status	31 - Alarm ON /Alarm OFF status	RO	-	32 bit int.
506	31 - Alarm Value	31 - Value of related alarm parameter	RO	-	32 bit float
508	31 - Alarm Timestamp	32 - Alarm time	RO	-	32 bit unix time
510	32 - Alarm ID	32 - Alarm ID	RO	-	32 bit int.
512	32 - Alarm Status	32 - Alarm ON /Alarm OFF status	RO	-	32 bit int.
514	32 - Alarm Value	32 - Value of related alarm parameter	RO	-	32 bit float
516	33 - Alarm Timestamp	33 - Alarm time	RO	-	32 bit unix time
518	33 - Alarm ID	33 - Alarm ID	RO	-	32 bit int.
520	33 - Alarm Status	33 - Alarm ON /Alarm OFF status	RO	-	32 bit int.
522	33 - Alarm Value	33 - Value of related alarm parameter	RO	-	32 bit float
524	34 - Alarm Timestamp	34 - Alarm time	RO	-	32 bit unix time
526	34 - Alarm ID	34 - Alarm ID	RO	-	32 bit int.
528	34 - Alarm Status	34 - Alarm ON /Alarm OFF status	RO	-	32 bit int.
530	34 - Alarm Value	34 - Value of related alarm parameter	RO	-	32 bit float
532	35 - Alarm Timestamp	35 - Alarm time	RO	-	32 bit unix time
534	35 - Alarm ID	35 - Alarm ID	RO	-	32 bit int.
536	35 - Alarm Status	35 - Alarm ON /Alarm OFF status	RO	-	32 bit int.
538	35 - Alarm Value	35 - Value of related alarm parameter	RO	-	32 bit float
540	36 - Alarm Timestamp	36 - Alarm time	RO	-	32 bit unix time
542	36 - Alarm ID	36 - Alarm ID	RO	-	32 bit int.

Address	Parameter	Description	R/W Descript.	Unit	Data Type
544	36 - Alarm Status	36 - Alarm ON /Alarm OFF status	RO	-	32 bit int.
546	36 - Alarm Value	36 - Value of related alarm parameter	RO	-	32 bit float
548	37 - Alarm Timestamp	37 - Alarm time	RO	-	32 bit unix time
550	37 - Alarm ID	37 - Alarm ID	RO	-	32 bit int.
552	37 - Alarm Status	37 - Alarm ON /Alarm OFF status	RO	-	32 bit int.
554	37 - Alarm Value	37 - Value of related alarm parameter	RO	-	32 bit float
556	38 - Alarm Timestamp	38 - Alarm time	RO	-	32 bit unix time
558	38 - Alarm ID	38 - Alarm ID	RO	-	32 bit int.
560	38 - Alarm Status	38 - Alarm ON /Alarm OFF status	RO	-	32 bit int.
562	38 - Alarm Value	38 - Value of related alarm parameter	RO	-	32 bit float
564	39 - Alarm Timestamp	39 - Alarm time	RO	-	32 bit unix time
566	39 - Alarm ID	39 - Alarm ID	RO	-	32 bit int.
568	39 - Alarm Status	39 - Alarm ON /Alarm OFF status	RO	-	32 bit int.
570	39 - Alarm Value	39 - Value of related alarm parameter	RO	-	32 bit float
572	40 - Alarm Timestamp	40 - Alarm time	RO	-	32 bit unix time
574	40 - Alarm ID	40 - Alarm ID	RO	-	32 bit int.
576	40 - Alarm Status	40 - Alarm ON /Alarm OFF status	RO	-	32 bit int.
578	40 - Alarm Value	40 - Value of related alarm parameter	RO	-	32 bit float
580	41 - Alarm Timestamp	41 - Alarm time	RO	-	32 bit unix time
582	41 - Alarm ID	41 - Alarm ID	RO	-	32 bit int.
584	41 - Alarm Status	41 - Alarm ON /Alarm OFF status	RO	-	32 bit int.
586	41 - Alarm Value	41 - Value of related alarm parameter	RO	-	32 bit float
588	42 - Alarm Timestamp	42 - Alarm time	RO	-	32 bit unix time
590	42 - Alarm ID	42 - Alarm ID	RO	-	32 bit int.
592	42 - Alarm Status	42 - Alarm ON /Alarm OFF status	RO	-	32 bit int.
594	42 - Alarm Value	42 - Value of related alarm parameter	RO	-	32 bit float
596	43 - Alarm Timestamp	43 - Alarm time	RO	-	32 bit unix time
598	43 - Alarm ID	43 - Alarm ID	RO	-	32 bit int.
600	43 - Alarm Status	43 - Alarm ON /Alarm OFF status	RO	-	32 bit int.
602	43 - Alarm Value	43 - Value of related alarm parameter	RO	-	32 bit float
604	44 - Alarm Timestamp	44 - Alarm time	RO	-	32 bit unix time
608	44 - Alarm Status	44 - Alarm ON /Alarm OFF status	RO	-	32 bit int.
610	44 - Alarm Value	44 - Value of related alarm parameter	RO	-	32 bit float
612	45 - Alarm Timestamp	45 - Alarm time	RO	-	32 bit unix time
614	45 - Alarm ID	45 - Alarm ID	RO	-	32 bit int.
616	45 - Alarm Status	45 - Alarm ON /Alarm OFF status	RO	-	32 bit int.
618	45 - Alarm Value	45 - Value of related alarm parameter	RO	-	32 bit float
620	46 - Alarm Timestamp	46 - Alarm time	RO	-	32 bit unix time
622	46 - Alarm ID	46 - Alarm ID	RO	-	32 bit int.
624	46 - Alarm Status	46 - Alarm ON /Alarm OFF status	RO	-	32 bit int.
626	46 - Alarm Value	46 - Value of related alarm parameter	RO	-	32 bit float
628	47 - Alarm Timestamp	47 - Alarm time	RO	-	32 bit unix time
630	47 - Alarm ID	47 - Alarm ID	RO	-	32 bit int.
632	47 - Alarm Status	47 - Alarm ON /Alarm OFF status	RO	-	32 bit int.

Address	Parameter	Description	R/W Descript.	Unit	Data Type
634	47 - Alarm Value	47 - Value of related alarm parameter	RO	-	32 bit float
636	48 - Alarm Timestamp	48 - Alarm time	RO	-	32 bit unix time
638	48 - Alarm ID	48 - Alarm ID	RO	-	32 bit int.
640	48 - Alarm Status	48 - Alarm ON /Alarm OFF status	RO	-	32 bit int.
642	48 - Alarm Value	48 - Value of related alarm parameter	RO	-	32 bit float
644	49 - Alarm Timestamp	49 - Alarm time	RO	-	32 bit unix time
646	49 - Alarm ID	49 - Alarm ID	RO	-	32 bit int.
648	49 - Alarm Status	49 - Alarm ON /Alarm OFF status	RO	-	32 bit int.
650	49 - Alarm Value	49 - Value of related alarm parameter	RO	-	32 bit float
652	50 - Alarm Timestamp	50 - Alarm time	RO	-	32 bit unix time
654	50 - Alarm ID	50 - Alarm ID	RO	-	32 bit int.
656	50 - Alarm Status	50 - Alarm ON /Alarm OFF status	RO	-	32 bit int.
658	50 - Alarm Value	50 - Value of related alarm parameter	RO	-	32 bit float
Last Saved File					
660	Hourly Archival File Nr.	Latest recorded hourly archival file number	RO	-	32 bit int.
662	Daily Archival File Nr.	Latest recorded daily archival file number	RO	-	32 bit int.
664	Monthly Archival File Nr.	Latest recorded monthly archival file number	RO	-	32 bit int.
Estimated Step Powers (DCM Values)					
666	Estimated S1 Power	Estimated Step 1 Power	RO	kVAr	32 bit float
668	Estimated S2 Power	Estimated Step 2 Power	RO	kVAr	32 bit float
670	Estimated S3 Power	Estimated Step 3 Power	RO	kVAr	32 bit float
672	Estimated S4 Power	Estimated Step 4 Power	RO	kVAr	32 bit float
674	Estimated S5 Power	Estimated Step 5 Power	RO	kVAr	32 bit float
676	Estimated S6 Power	Estimated Step 6 Power	RO	kVAr	32 bit float
678	Estimated S7 Power	Estimated Step 7 Power	RO	kVAr	32 bit float
680	Estimated S8 Power	Estimated Step 8 Power	RO	kVAr	32 bit float
682	Estimated S9 Power	Estimated Step 9 Power	RO	kVAr	32 bit float
684	Estimated S10 Power	Estimated Step 10 Power	RO	kVAr	32 bit float
686	Estimated S11 Power	Estimated Step 11 Power	RO	kVAr	32 bit float
688	Estimated S12 Power	Estimated Step 12 Power	RO	kVAr	32 bit float
Generator Input					
690	Gen Input	Jenerator Active/Passive Status	RO	-	32 bit int.
Energy Meters (64 bit)					
692	T1 Imp. Active Index	Tariff 1 Import Active Index	RO	kWh	64 bit double
696	T1 Exp. Active Index	Tariff 1 ExportActive Index	RO	kWh	64 bit double
700	T1 Ind. Reactive Index	Tariff 1 Inductive Reactive Index	RO	kVArh	64 bit double
704	T1 Cap. Reactive Index	Tariff 1 Capacitive Reactive Index	RO	kVArh	64 bit double

Unix time: Unix time is the number of seconds elapsed since midnight (00:00) Coordinated Universal Time (UTC) of January 1, 1970, not counting leaps seconds.

NOTE: Tariff Meters' Index Values can be read in 32 bit and/or 64bit floating point format. Mathematically, 64bit floating point representation is more accurate than 32 bit floating point format.

e.g.

When it is required to read "Tariff 1 Import Active Index" value, it can be received either 32 bit floating point format (modbus adr. 458) or in 64 bit floating point format (modbus adr.

1016).

If related index value is wanted to read more sensitive, 64bit versions must be selected.

4.5.1.1.1 Alarm Flags(RAPIDUS 211R-E)

If any bit's value is "1", then there is alarm for that bit. On the contrary, a bit value of "1" means that there is NO alarm for that bit.

The contents of alarm flag variables are listed below.

Alarms 1

b7 THDV	b6 I	b5 I	b4 I	b3 V	b2 V	b1 V	b0 Temp.
b15 -	b14 -	b13 -	b12 V Harmonics	b11 V Harmonics	b10 V Harmonics	b9 THDV	b8 THDV
b23 S	b22 Q	b21 Q	b20 Q	b19 P	b18 P	b17 P	b16 -
b31 PF	b30 PF	b29 PF	b28 COSØ	b27 COSØ	b26 COSØ	b25 S	b24 S

Alarms 2

b7 I Harmonics	b6 I Harmonics	b5 THDV	b4 THDV	b3 THDV	b2 F	b1 F	b0 F
b15 Step	b14 Step1	b13 Under Comp.	b12 Over Comp.	b11 Cap. Energy	b10 Ind. Energy	b9 Battery	b8 I Harmonics
b23 Step 10	b22 Step 9	b21 Step 8	b20 Step 7	b19 Step 6	b18 Step 5	b17 Step 4	b16 Step 3
b31 -	b30 -	b29 -	b28 -	b27 -	b26 -	b25 Step 12	b24 Step 11

Abbreviations used for the Alarm Flags :

<i>Temp. :</i>	Temperature	<i>Cap. Energy:</i>	Capacitive Energy
<i>V :</i>	Voltage	<i>Over Comp:</i>	Over Compansation
<i>I :</i>	Current	<i>Under Comp:</i>	Under Compansation
<i>THDV:</i>	Total Harmonic Distortion in Voltage	<i>Step 1:</i>	Step 1 Low Limit Value Alarm
<i>V Harmonics:</i>	Voltage Harmonics	<i>Step 2:</i>	Step 2 Low Limit Value Alarm
<i>P:</i>	Active Power	<i>Step 3:</i>	Step 3 Low Limit Value Alarm
<i>Q:</i>	ReActive Power	<i>Step 4:</i>	Step 4 Low Limit Value Alarm
<i>S:</i>	Apperant Power	<i>Step 5:</i>	Step 5 Low Limit Value Alarm
<i>CosØ :</i>	CosØ	<i>Step 6:</i>	Step 6 Low Limit Value Alarm
<i>PF:</i>	Power Factor	<i>Step 7:</i>	Step 7 Low Limit Value Alarm
<i>F:</i>	Frequency	<i>Step 8:</i>	Step 8 Low Limit Value Alarm
<i>THDI:</i>	Total Harmonic Distortion in Current	<i>Step 9:</i>	Step 9 Low Limit Value Alarm
<i>I Harmonics:</i>	Current Harmonics	<i>Step 10:</i>	Step 10 Low Limit Value Alarm
<i>Battery:</i>	Battery Voltage	<i>Step 11:</i>	Step 11 Low Limit Value Alarm
<i>Ind. Energy:</i>	Indüktive Energy	<i>Step 12:</i>	Step 12 Low Limit Value Alarm

4.5.1.2 Readable Data for RAPIDUS 212R-E

Table 4-5 Readable Data(RAPIDUS 212R-E)

Address	Parameter	Description	R/W	Unit	Data Type
0	V	Voltage	RO	V	32 bit float
2	I	Current	RO	A	32 bit float
4	P	Total active power	RO	W	32 bit float
6	Q	Total reactive power	RO	VAr	32 bit float
8	S	Total apparent power	RO	VA	32 bit float
10	CosØ	System CosØ	RO	-	32 bit float
12	PF	System PF	RO	-	32 bit float
14	F	System Frequency	RO	Hz	32 bit float
16	THDV	Total har. distortion of voltage	RO	%	32 bit float
18	THDI	Total har. distortion of current	RO	%	32 bit float
20	V Harmonic 1	Voltage 1st harmonics	RO	%	32 bit float
22	V Harmonic 3	Voltage 3rd harmonics	RO	%	32 bit float
24	V Harmonic 5	Voltage 5th harmonics	RO	%	32 bit float
26	V Harmonic 7	Voltage 7th harmonics	RO	%	32 bit float
28	V Harmonic 9	Voltage 9th harmonics	RO	%	32 bit float
30	V Harmonic 11	Voltage 11th harmonics	RO	%	32 bit float
32	V Harmonic 13	Voltage 13th harmonics	RO	%	32 bit float
34	V Harmonic 15	Voltage 15th harmonics	RO	%	32 bit float
36	V Harmonic 17	Voltage 17th harmonics	RO	%	32 bit float
38	V Harmonic 19	Voltage 19th harmonics	RO	%	32 bit float
40	V Harmonic 21	Voltage 21st harmonics	RO	%	32 bit float
42	V Harmonic 23	Voltage 23rd harmonics	RO	%	32 bit float
44	V Harmonic 25	Voltage 25th harmonics	RO	%	32 bit float
46	V Harmonic 27	Voltage 27th harmonics	RO	%	32 bit float
48	V Harmonic 29	Voltage 29th harmonics	RO	%	32 bit float

Address	Parameter	Description	R/W	Unit	Data Type
50	V Harmonic 31	Voltage 31st harmonics	RO	%	32 bit float
52	V Harmonic 33	Voltage 33rd harmonics	RO	%	32 bit float
54	V Harmonic 35	Voltage 35th harmonics	RO	%	32 bit float
56	V Harmonic 37	Voltage 37th harmonics	RO	%	32 bit float
58	V Harmonic 39	Voltage 39th harmonics	RO	%	32 bit float
60	V Harmonic 41	Voltage 41th harmonics	RO	%	32 bit float
62	V Harmonic 43	Voltage 43rd harmonics	RO	%	32 bit float
64	V Harmonic 45	Voltage 45th harmonics	RO	%	32 bit float
66	V Harmonic 47	Voltage 47th harmonics	RO	%	32 bit float
68	V Harmonic 49	Voltage 49th harmonics	RO	%	32 bit float
70	V Harmonic 51	Voltage 51st harmonics	RO	%	32 bit float
72	I Harmonic 1	Current 1st harmonics	RO	%	32 bit float
74	I Harmonic 3	Voltage 3rd harmonics	RO	%	32 bit float
76	I Harmonic 5	Voltage 5th harmonics	RO	%	32 bit float
78	I Harmonic 7	Voltage 7th harmonics	RO	%	32 bit float
80	I Harmonic 9	Voltage 9th harmonics	RO	%	32 bit float
82	I Harmonic 11	Voltage 11th harmonics	RO	%	32 bit float
84	I Harmonic 13	Voltage 13th harmonics	RO	%	32 bit float
86	I Harmonic 15	Voltage 15th harmonics	RO	%	32 bit float
88	I Harmonic 17	Voltage 17th harmonics	RO	%	32 bit float
90	I Harmonic 19	Voltage 19th harmonics	RO	%	32 bit float
92	I Harmonic 21	Voltage 21st harmonics	RO	%	32 bit float
94	I Harmonic 23	Voltage 23rd harmonics	RO	%	32 bit float
96	I Harmonic 25	Voltage 25th harmonics	RO	%	32 bit float
98	I Harmonic 27	Voltage 27th harmonics	RO	%	32 bit float
100	I Harmonic 29	Voltage 29th harmonics	RO	%	32 bit float
102	I Harmonic 31	Voltage 31st harmonics	RO	%	32 bit float
104	I Harmonic 33	Voltage 33rd harmonics	RO	%	32 bit float
106	I Harmonic 35	Voltage 35th harmonics	RO	%	32 bit float
108	I Harmonic 37	Voltage 37th harmonics	RO	%	32 bit float
110	I Harmonic 39	Voltage 39th harmonics	RO	%	32 bit float
112	I Harmonic 41	Voltage 41th harmonics	RO	%	32 bit float
114	I Harmonic 43	Voltage 43rd harmonics	RO	%	32 bit float
116	I Harmonic 45	Voltage 45th harmonics	RO	%	32 bit float
118	I Harmonic 47	Voltage 47th harmonics	RO	%	32 bit float
120	I Harmonic 49	Voltage 49th harmonics	RO	%	32 bit float
122	I Harmonic 51	Voltage 51th harmonics	RO	%	32 bit float
Alarm					
124	Alarms 1	Alarm flag 1 (first 32 bit)	RO	-	32 bit int.
126	Alarms 2	Alarm flag 2 (second 32 bit)	RO	-	32 bit int.
Step					
146	S7 switching count	Step 7 switching count	RO	-	32 bit int.
148	S8 switching count	Step 8 switching count	RO	-	32 bit int.
150	S9 switching count	Step 9 switching count	RO	-	32 bit int.

Address	Parameter	Description	R/W	Unit	Data Type
152	S10 switching count	Step 10 switching count	RO	-	32 bit int.
154	S11 switching count	Step 11 switching count	RO	-	32 bit int.
156	S12 switching count	Step 12 switching count	RO	-	32 bit int.
158	S13 switching count	Step 13 switching count	RO	-	32 bit int.
160	S14 switching count	Step 14 switching count	RO	-	32 bit int.
162	S15 switching count	Step 15 switching count	RO	-	32 bit int.
164	S16 switching count	Step 16 switching count	RO	-	32 bit int.
166	S17 switching count	Step 17 switching count	RO	-	32 bit int.
162	S15 switching count	Step 15 switching count	RO	-	32 bit int.
164	S16 switching count	Step 16 switching count	RO	-	32 bit int.
166	S17 switching count	Step 17 switching count	RO	-	32 bit int.
168	S18 switching count	Step 18 switching count	RO	-	32 bit int.
170	S19 switching count	Step 19 switching count	RO	-	32 bit int.
172	S20 switching count	Step 20 switching count	RO	-	32 bit int.
174	S21 switching count	Step 21 switching count	RO	-	32 bit int.
176	S22 switching count	Step 22 switching count	RO	-	32 bit int.
178	S23 switching count	Step 23 switching count	RO	-	32 bit int.
180	S24 switching count	Step 24 switching count	RO	-	32 bit int.
182	S1 operation time	Step 1 operation time	RO	min.	32 bit int.
184	S2 operation time	Step 2 operation time	RO	min.	32 bit int.
186	S3 operation time	Step 3 operation time	RO	min.	32 bit int.
188	S4 operation time	Step 4 operation time	RO	min.	32 bit int.
190	S5 operation time	Step 5 operation time	RO	min.	32 bit int.
192	S6 operation time	Step 6 operation time	RO	min.	32 bit int.
194	S7 operation time	Step 7 operation time	RO	min.	32 bit int.
196	S8 operation time	Step 8 operation time	RO	min.	32 bit int.
198	S9 operation time	Step 9 operation time	RO	min.	32 bit int.
200	S10 operation time	Step 10 operation time	RO	min.	32 bit int.
202	S11 operation time	Step 11 operation time	RO	min.	32 bit int.
204	S12 operation time	Step 12 operation time	RO	min.	32 bit int.
206	S13 operation time	Step 13 operation time	RO	min.	32 bit int.
208	S14 operation time	Step 14 operation time	RO	min.	32 bit int.
210	S15 operation time	Step 15 operation time	RO	min.	32 bit int.
212	S16 operation time	Step 16 operation time	RO	min.	32 bit int.
214	S17 operation time	Step 17 operation time	RO	min.	32 bit int.
216	S18 operation time	Step 18 operation time	RO	min.	32 bit int.
218	S19 operation time	Step 19 operation time	RO	min.	32 bit int.
220	S20 operation time	Step 20 operation time	RO	min.	32 bit int.
222	S21 operation time	Step 21 operation time	RO	min.	32 bit int.
224	S22 operation time	Step 22 operation time	RO	min.	32 bit int.
226	S23 operation time	Step 23 operation time	RO	min.	32 bit int.
228	S24 operation time	Step 24 operation time	RO	min.	32 bit int.
Energy Meters (32 bit)					
230	Imp. Act. Index	Import Active Index	RO	kWh	32 bit float

Address	Parameter	Description	R/W	Unit	Data Type
232	Imp. Act. Curr. Hour	Import Active Current Hour	RO	kWh	32 bit float
234	Imp. Act. Prev. Hour	Import Active Previous Hour	RO	kWh	32 bit float
236	Imp. Act. Curr. Day	Import. Active Current Day	RO	kWh	32 bit float
238	Imp. Act. Prev. Day	Import Active Previous Day	RO	kWh	32 bit float
240	Imp. Act. Curr. Month	Import Active Current Month	RO	kWh	32 bit float
242	Imp. Act. Prev. Month	Import Previous Month	RO	kWh	32 bit float
244	Exp. Act. Index	Export Active Index	RO	kWh	32 bit float
246	Exp. Act. Curr. Hour	Export Active Current Hour	RO	kWh	32 bit float
248	Exp. Act. Prev. Hour	Export Active Previous Hour	RO	kWh	32 bit float
250	Exp. Act. Curr. Day	Export Active Current Day	RO	kWh	32 bit float
252	Exp. Act. Prev. Day	Export Active Previous Day	RO	kWh	32 bit float
254	Exp. Act. Curr. Month	Export Active Current Month	RO	kWh	32 bit float
256	Exp. Act. Prev. Month	Export Active Previous Month	RO	kWh	32 bit float
258	Ind. React. Index	Inductive Reactive Index	RO	kVArh	32 bit float
260	Ind. React. Curr. Hour	Inductive Reactive Current Hour	RO	kVArh	32 bit float
262	Ind. React. Prev. Hour	Inductive Reactive Previous Hour	RO	kVArh	32 bit float
264	Ind. React. Curr. Day	Inductive Reactive Current Day	RO	kVArh	32 bit float
266	Ind. React. Prev. Day	Inductive Reactive Previous Day	RO	kVArh	32 bit float
268	Ind. React. Curr. Month	Inductive Reactive Current Month	RO	kVArh	32 bit float
270	Ind. React. Prev. Month	Inductive Reactive Previous Month	RO	kVArh	32 bit float
272	Cap. React. Index	Capacitive Reactive Index	RO	kVArh	32 bit float
274	Cap. React. Curr. Hour	Capacitive Reactive Current Hour	RO	kVArh	32 bit float
276	Cap. React. Prev. Hour	Capacitive Reactive Previous Hour	RO	kVArh	32 bit float
278	Cap. React. Curr. Day	Capacitive Reactive Current Day	RO	kVArh	32 bit float
280	Cap. React. Prev. Day	Capacitive Reactive Previous Day	RO	kVArh	32 bit float
282	Cap. React. Curr. Month	Capacitive Reactive Current Month	RO	kVArh	32 bit float
284	Cap. React. Prev. Month	Capacitive Reactive Previous Month	RO	kVArh	32 bit float
Demand					
286	P tot.	Total active power demand	RO	W	32 bit float
288	P tot. time	Total active power demand time	RO	-	32 bit unix time
290	I tot.	Total current demand	RO	A	32 bit float
292	I tot. time	Total current demand time	RO	-	32 bit unix time
294	Q tot.	Total reactive power demand	RO	VAr	32 bit float
296	Q tot. time	Total reactive power demand time	RO	-	32 bit unix time
298	S tot.	Total apperant power demand	RO	VA	32 bit float
300	S tot. time	Total apperant power demand time	RO	-	32 bit unix time
Other					
302	Temp.	Temperature Value	RO	°C	32 bit float
304	Battery Voltage	-	RO	V	32 bit float
306	Time	System Date and Time	R/W	-	32 bit unix time
Alarm Status					
308	1 - Alarm Timestamp	1 - Alarm time	RO	-	32 bit unix time
310	1 - Alarm ID	1 - Alarm ID	RO	-	32 bit int.
312	1 - Alarm Status	1 - Alarm ON /Alarm OFF status	RO	-	32 bit int.

Address	Parameter	Description	R/W	Unit	Data Type
314	1 - Alarm Value	1 - Value of related alarm parameter	RO	-	32 bit float
316	2 - Alarm Timestamp	2 - Alarm time	RO	-	32 bit unix time
318	2 - Alarm ID	2 - Alarm ID	RO	-	32 bit int.
320	2 - Alarm Status	2 - Alarm ON /Alarm OFF status	RO	-	32 bit int.
322	2 - Alarm Value	2 - Value of related alarm parameter	RO	-	32 bit float
324	3 - Alarm Timestamp	3 - Alarm time	RO	-	32 bit unix time
326	3 - Alarm ID	3 - Alarm ID	RO	-	32 bit int.
328	3 - Alarm Status	3 - Alarm ON /Alarm OFF status	RO	-	32 bit int.
330	3 - Alarm Value	3 - Value of related alarm parameter	RO	-	32 bit float
332	4 - Alarm Timestamp	4 - Alarm time	RO	-	32 bit unix time
334	4 - Alarm ID	4 - Alarm ID	RO	-	32 bit int.
336	4 - Alarm Status	4 - Alarm ON /Alarm OFF status	RO	-	32 bit int.
338	4 - Alarm Value	4 - Value of related alarm parameter	RO	-	32 bit float
340	5 - Alarm Timestamp	5 - Alarm time	RO	-	32 bit unix time
342	5 - Alarm ID	5 - Alarm ID	RO	-	32 bit int.
344	5 - Alarm Status	5 - Alarm ON /Alarm OFF status	RO	-	32 bit int.
346	5 - Alarm Value	5 - Value of related alarm parameter	RO	-	32 bit float
348	6 - Alarm Timestamp	6 - Alarm time	RO	-	32 bit unix time
350	6 - Alarm ID	6 - Alarm ID	RO	-	32 bit int.
352	6 - Alarm Status	6 - Alarm ON /Alarm OFF status	RO	-	32 bit int.
354	6 - Alarm Value	6 - Value of related alarm parameter	RO	-	32 bit float
356	7 - Alarm Timestamp	7 - Alarm time	RO	-	32 bit unix time
358	7 - Alarm ID	7 - Alarm ID	RO	-	32 bit int.
360	7 - Alarm Status	7 - Alarm ON /Alarm OFF status	RO	-	32 bit int.
362	7 - Alarm Value	7 - Value of related alarm parameter	RO	-	32 bit float
364	8 - Alarm Timestamp	8 - Alarm time	RO	-	32 bit unix time
366	8 - Alarm ID	8 - Alarm ID	RO	-	32 bit int.
368	8 - Alarm Status	8 - Alarm ON /Alarm OFF status	RO	-	32 bit int.
370	8 - Alarm Value	8 - Value of related alarm parameter	RO	-	32 bit float
372	9 - Alarm Timestamp	9 - Alarm time	RO	-	32 bit unix time
374	9 - Alarm ID	9 - Alarm ID	RO	-	32 bit int.
376	9 - Alarm Status	9 - Alarm ON /Alarm OFF status	RO	-	32 bit int.
378	9 - Alarm Value	9 - Value of related alarm parameter	RO	-	32 bit float
380	10 - Alarm Timestamp	10 - Alarm time	RO	-	32 bit unix time
382	10 - Alarm ID	10 - Alarm ID	RO	-	32 bit int.
384	10 - Alarm Status	10 - Alarm ON /Alarm OFF status	RO	-	32 bit int.
386	10 - Alarm Value	10 - Value of related alarm parameter	RO	-	32 bit float
388	11 - Alarm Timestamp	11 - Alarm time	RO	-	32 bit unix time
390	11 - Alarm ID	11 - Alarm ID	RO	-	32 bit int.
392	11 - Alarm Status	11 - Alarm ON /Alarm OFF status	RO	-	32 bit int.
394	11 - Alarm Value	11 - Value of related alarm parameter	RO	-	32 bit float
396	12 - Alarm Timestamp	12 - Alarm time	RO	-	32 bit unix time
398	12 - Alarm ID	12 - Alarm ID	RO	-	32 bit int.
400	12 - Alarm Status	12 - Alarm ON /Alarm OFF status	RO	-	32 bit int.

Address	Parameter	Description	R/W	Unit	Data Type
402	12 - Alarm Value	12 - Value of related alarm parameter	RO	-	32 bit float
404	13 - Alarm Timestamp	13 - Alarm time	RO	-	32 bit unix time
406	13 - Alarm ID	13 - Alarm ID	RO	-	32 bit int.
408	13 - Alarm Status	13 - Alarm ON /Alarm OFF status	RO	-	32 bit int.
410	13 - Alarm Value	13 - Value of related alarm parameter	RO	-	32 bit float
412	14 - Alarm Timestamp	14 - Alarm time	RO	-	32 bit unix time
414	14 - Alarm ID	14 - Alarm ID	RO	-	32 bit int.
416	14 - Alarm Status	14 - Alarm ON /Alarm OFF status	RO	-	32 bit int.
418	14 - Alarm Value	14 - Value of related alarm parameter	RO	-	32 bit float
420	15 - Alarm Timestamp	15 - Alarm zaman değeri	RO	-	32 bit unix time
422	15 - Alarm ID	15 - Alarm ID	RO	-	32 bit int.
424	15 - Alarm Status	15 - Alarm ON /Alarm OFF status	RO	-	32 bit int.
426	15 - Alarm Value	15 - Value of related alarm parameter	RO	-	32 bit float
428	16 - Alarm Timestamp	16 - Alarm time	RO	-	32 bit unix time
430	16 - Alarm ID	16 - Alarm ID	RO	-	32 bit int.
432	16 - Alarm Status	16 - Alarm ON /Alarm OFF status	RO	-	32 bit int.
434	16 - Alarm Value	16 - Value of related alarm parameter	RO	-	32 bit float
436	17 - Alarm Timestamp	17 - Alarm time	RO	-	32 bit unix time
438	17 - Alarm ID	17 - Alarm ID	RO	-	32 bit int.
440	17 - Alarm Status	17 - Alarm ON /Alarm OFF status	RO	-	32 bit int.
442	17 - Alarm Value	17 - Value of related alarm parameter	RO	-	32 bit float
444	18 - Alarm Timestamp	18 - Alarm time	RO	-	32 bit unix time
446	18 - Alarm ID	18 - Alarm ID	RO	-	32 bit int.
448	18 - Alarm Status	18 - Alarm ON /Alarm OFF status	RO	-	32 bit int.
450	18 - Alarm Value	18 - Value of related alarm parameter	RO	-	32 bit float
452	19 - Alarm Timestamp	19 - Alarm time	RO	-	32 bit unix time
454	19 - Alarm ID	19 - Alarm ID	RO	-	32 bit int.
456	19 - Alarm Status	19 - Alarm ON /Alarm OFF status	RO	-	32 bit int.
458	19 - Alarm Value	19 - Value of related alarm parameter	RO	-	32 bit float
460	20 - Alarm Timestamp	20 - Alarm time	RO	-	32 bit unix time
462	20 - Alarm ID	20 - Alarm ID	RO	-	32 bit int.
464	20 - Alarm Status	20 - Alarm ON /Alarm OFF status	RO	-	32 bit int.
466	20 - Alarm Value	20 - Value of related alarm parameter	RO	-	32 bit float
468	21 - Alarm Timestamp	21 - Alarm time	RO	-	32 bit unix time
470	21 - Alarm ID	21 - Alarm ID	RO	-	32 bit int.
472	21 - Alarm Status	21 - Alarm ON /Alarm OFF status	RO	-	32 bit int.
474	21 - Alarm Value	21 - Value of related alarm parameter	RO	-	32 bit float
476	22 - Alarm Timestamp	22 - Alarm time	RO	-	32 bit unix time
478	22 - Alarm ID	22 - Alarm ID	RO	-	32 bit int.
480	22 - Alarm Status	22 - Alarm ON /Alarm OFF status	RO	-	32 bit int.
482	22 - Alarm Value	22 - Value of related alarm parameter	RO	-	32 bit float
484	23 - Alarm Timestamp	23 - Alarm time	RO	-	32 bit unix time
486	23 - Alarm ID	23 - Alarm ID	RO	-	32 bit int.
488	23 - Alarm Status	23 - Alarm ON /Alarm OFF status	RO	-	32 bit int.
490	23 - Alarm Value	23 - Value of related alarm parameter	RO	-	32 bit float

Address	Parameter	Description	R/W	Unit	Data Type
492	24 - Alarm Timestamp	24 - Alarm time	RO	-	32 bit unix time
494	24 - Alarm ID	24 - Alarm ID	RO	-	32 bit int.
496	24 - Alarm Status	24 - Alarm ON /Alarm OFF status	RO	-	32 bit int.
498	24 - Alarm Value	24 - Value of related alarm parameter	RO	-	32 bit float
500	25 - Alarm Timestamp	25 - Alarm time	RO	-	32 bit unix time
502	25 - Alarm ID	25 - Alarm ID	RO	-	32 bit int.
504	25 - Alarm Status	25 - Alarm ON /Alarm OFF status	RO	-	32 bit int.
506	25 - Alarm Value	25 - Value of related alarm parameter	RO	-	32 bit float
508	26 - Alarm Timestamp	26 - Alarm time	RO	-	32 bit unix time
510	26 - Alarm ID	26 - Alarm ID	RO	-	32 bit int.
512	26 - Alarm Status	26 - Alarm ON /Alarm OFF status	RO	-	32 bit int.
514	26 - Alarm Value	26 - Value of related alarm parameter	RO	-	32 bit float
516	27 - Alarm Timestamp	27 - Alarm time	RO	-	32 bit unix time
518	27 - Alarm ID	27 - Alarm ID	RO	-	32 bit int.
520	27 - Alarm Status	27 - Alarm ON /Alarm OFF status	RO	-	32 bit int.
522	27 - Alarm Value	27 - Value of related alarm parameter	RO	-	32 bit float
524	28 - Alarm Timestamp	28 - Alarm time	RO	-	32 bit unix time
526	28 - Alarm ID	28 - Alarm ID	RO	-	32 bit int.
528	28 - Alarm Status	28 - Alarm ON /Alarm OFF status	RO	-	32 bit int.
530	28 - Alarm Value	28 - Value of related alarm parameter	RO	-	32 bit float
532	29 - Alarm Timestamp	29 - Alarm time	RO	-	32 bit unix time
534	29 - Alarm ID	29 - Alarm ID	RO	-	32 bit int.
536	29 - Alarm Status	29 - Alarm ON /Alarm OFF status	RO	-	32 bit int.
538	29 - Alarm Value	29 - Value of related alarm parameter	RO	-	32 bit float
540	30 - Alarm Timestamp	30 - Alarm time	RO	-	32 bit unix time
542	30 - Alarm ID	30 - Alarm ID	RO	-	32 bit int.
544	30 - Alarm Status	30 - Alarm ON /Alarm OFF status	RO	-	32 bit int.
546	30 - Alarm Value	30 - Value of related alarm parameter	RO	-	32 bit float
548	31 - Alarm Timestamp	31 - Alarm time	RO	-	32 bit unix time
550	31 - Alarm ID	31 - Alarm ID	RO	-	32 bit int.
552	31 - Alarm Status	31 - Alarm ON /Alarm OFF status	RO	-	32 bit int.
554	31 - Alarm Value	31 - Value of related alarm parameter	RO	-	32 bit float
556	31 - Alarm Timestamp	32 - Alarm time	RO	-	32 bit unix time
558	32 - Alarm ID	32 - Alarm ID	RO	-	32 bit int.
560	32 - Alarm Status	32 - Alarm ON /Alarm OFF status	RO	-	32 bit int.
562	32 - Alarm Value	32 - Value of related alarm parameter	RO	-	32 bit float
564	33 - Alarm Timestamp	33 - Alarm time	RO	-	32 bit unix time
566	33 - Alarm ID	33 - Alarm ID	RO	-	32 bit int.
568	33 - Alarm Status	33 - Alarm ON /Alarm OFF status	RO	-	32 bit int.
570	33 - Alarm Value	33 - Value of related alarm parameter	RO	-	32 bit float
572	34 - Alarm Timestamp	34 - Alarm time	RO	-	32 bit unix time

Address	Parameter	Description	R/W	Unit	Data Type
574	34 - Alarm ID	34 - Alarm ID	RO	-	32 bit int.
576	34 - Alarm Status	34 - Alarm ON /Alarm OFF status	RO	-	32 bit int.
578	34 - Alarm Value	34 - Value of related alarm parameter	RO	-	32 bit float
580	35 - Alarm Timestamp	35 - Alarm time	RO	-	32 bit unix time
582	35 - Alarm ID	35 - Alarm ID	RO	-	32 bit int.
584	35 - Alarm Status	35 - Alarm ON /Alarm OFF status	RO	-	32 bit int.
586	35 - Alarm Value	35 - Value of related alarm parameter	RO	-	32 bit float
588	36 - Alarm Timestamp	36 - Alarm time	RO	-	32 bit unix time
590	36 - Alarm ID	36 - Alarm ID	RO	-	32 bit int.
592	36 - Alarm Status	36 - Alarm ON /Alarm OFF status	RO	-	32 bit int.
594	36 - Alarm Value	36 - Value of related alarm parameter	RO	-	32 bit float
596	37 - Alarm Timestamp	37 - Alarm time	RO	-	32 bit unix time
598	37 - Alarm ID	37 - Alarm ID	RO	-	32 bit int.
600	37 - Alarm Status	37 - Alarm ON /Alarm OFF status	RO	-	32 bit int.
602	37 - Alarm Value	37 - Value of related alarm parameter	RO	-	32 bit float
604	38 - Alarm Timestamp	38 - Alarm time	RO	-	32 bit unix time
606	38 - Alarm ID	38 - Alarm ID	RO	-	32 bit int.
608	38 - Alarm Status	38 - Alarm ON /Alarm OFF status	RO	-	32 bit int.
610	38 - Alarm Value	38 - Value of related alarm parameter	RO	-	32 bit float
612	39 - Alarm Timestamp	39 - Alarm time	RO	-	32 bit unix time
614	39 - Alarm ID	39 - Alarm ID	RO	-	32 bit int.
616	39 - Alarm Status	39 - Alarm ON /Alarm OFF status	RO	-	32 bit int.
618	39 - Alarm Value	39 - Value of related alarm parameter	RO	-	32 bit float
620	40 - Alarm Timestamp	40 - Alarm time	RO	-	32 bit unix time
622	40 - Alarm ID	40 - Alarm ID	RO	-	32 bit int.
624	40 - Alarm Status	40 - Alarm ON /Alarm OFF status	RO	-	32 bit int.
626	40 - Alarm Value	40 - Value of related alarm parameter	RO	-	32 bit float
628	41 - Alarm Timestamp	41 - Alarm time	RO	-	32 bit unix time
630	41 - Alarm ID	41 - Alarm ID	RO	-	32 bit int.
632	41 - Alarm Status	41 - Alarm ON /Alarm OFF status	RO	-	32 bit int.
634	41 - Alarm Value	41 - Value of related alarm parameter	RO	-	32 bit float
636	42 - Alarm Timestamp	42 - Alarm time	RO	-	32 bit unix time
638	42 - Alarm ID	42 - Alarm ID	RO	-	32 bit int.
640	42 - Alarm Status	42 - Alarm ON /Alarm OFF status	RO	-	32 bit int.
642	42 - Alarm Value	42 - Value of related alarm parameter	RO	-	32 bit float
644	43 - Alarm Timestamp	43 - Alarm time	RO	-	32 bit unix time
646	43 - Alarm ID	43 - Alarm ID	RO	-	32 bit int.
648	43 - Alarm Status	43 - Alarm ON /Alarm OFF status	RO	-	32 bit int.
650	43 - Alarm Value	43 - Value of related alarm parameter	RO	-	32 bit float
652	44 - Alarm Timestamp	44 - Alarm time	RO	-	32 bit unix time
654	44 - Alarm ID	44 - Alarm ID	RO	-	32 bit int.
656	44 - Alarm Status	44 - Alarm ON /Alarm OFF status	RO	-	32 bit int.
658	44 - Alarm Value	44 - Value of related alarm parameter	RO	-	32 bit float

Address	Parameter	Description	R/W	Unit	Data Type
660	45 - Alarm Timestamp	45 - Alarm time	RO	-	32 bit unix time
662	45 - Alarm ID	45 - Alarm ID	RO	-	32 bit int.
664	45 - Alarm Status	45 - Alarm ON /Alarm OFF status	RO	-	32 bit int.
666	45 - Alarm Value	45 - Value of related alarm parameter	RO	-	32 bit float
668	46 - Alarm Timestamp	46 - Alarm time	RO	-	32 bit unix time
670	46 - Alarm ID	46 - Alarm ID	RO	-	32 bit int.
672	46 - Alarm Status	46 - Alarm ON /Alarm OFF status	RO	-	32 bit int.
674	46 - Alarm Value	46 - Value of related alarm parameter	RO	-	32 bit float
676	47 - Alarm Timestamp	47 - Alarm time	RO	-	32 bit unix time
678	47 - Alarm ID	47 - Alarm ID	RO	-	32 bit int.
680	47 - Alarm Status	47 - Alarm ON /Alarm OFF status	RO	-	32 bit int.
682	47 - Alarm Value	47 - Value of related alarm parameter	RO	-	32 bit float
684	48 - Alarm Timestamp	48 - Alarm time	RO	-	32 bit unix time
686	48 - Alarm ID	48 - Alarm ID	RO	-	32 bit int.
688	48 - Alarm Status	48 - Alarm ON /Alarm OFF status	RO	-	32 bit int.
690	48 - Alarm Value	48 - Value of related alarm parameter	RO	-	32 bit float
692	49 - Alarm Timestamp	49 - Alarm time	RO	-	32 bit unix time
694	49 - Alarm ID	49 - Alarm ID	RO	-	32 bit int.
696	49 - Alarm Status	49 - Alarm ON /Alarm OFF status	RO	-	32 bit int.
698	49 - Alarm Value	49 - Value of related alarm parameter	RO	-	32 bit float
700	50 - Alarm Timestamp	50 - Alarm time	RO	-	32 bit unix time
702	50 - Alarm ID	50 - Alarm ID	RO	-	32 bit int.
704	50 - Alarm Status	50 - Alarm ON /Alarm OFF status	RO	-	32 bit int.
706	50 - Alarm Value	50 - Value of related alarm parameter	RO	-	32 bit float
Last Saved File					
708	Hourly Archival File Nr.	Latest recorded hourly archival file number	RO	-	32 bit int.
710	Daily Archival File Nr.	Latest recorded daily archival file number	RO	-	32 bit int.
712	Monthly Archival File Nr.	Latest recorded monthly archival file number	RO	-	32 bit int.
Generator Input					
714	Gen Input	Jenerator Active/Passive Status	RO	-	32 bit int.
Energy Meters (64 bit)					
716	Imp. Active Index	Import Active Index	RO	kWh	64 bit double
720	Exp. Active Index	ExportActive Index	RO	kWh	64 bit double
724	Ind. Reactive Index	Inductive Reactive Index	RO	kVArh	64 bit double
728	Cap. Reactive Index	Capacitive Reactive Index	RO	kVArh	64 bit double

Unix time: Unix time is the number of seconds elapsed since midnight (00:00) Coordinated Universal Time (UTC) of January 1, 1970, not counting leaps seconds.

NOTE: Tariff Meters' Index Values can be read in 32 bit and/or 64bit floating point format. Mathematically, 64bit floating point representation is more accurate than 32 bit floating point format.

e.g.

When it is required to read “Import Active Index” value, it can be received either 32 bit floating point format (modbus adr. 230) or in 64 bit floating point format (modbus adr.716).

If related index value is wanted to read more sensitive, 64bit versions must be selected.

4.5.1.2.1 Alarm Flags(RAPIDUS 212R-E)

Each bit of an alarm flag variable corresponds to ‘one’ alarm flag.

If any bit’s value is “1”, then there is alarm for that bit. On the contrary, a bit value of “1” means that there is NO alarm for that bit.

The contents of alarm flag variables are listed below

Alarms 1

b7 THDV	b6 I	b5 I	b4 I	b3 V	b2 V	b1 V	b0 Temp.
b15 -	b14 -	b13 -	b12 V Harmonics	b11 V Harmonics	b10 V Harmonics	b9 THDV	b8 THDV
b23 S	b22 Q	b21 Q	b20 Q	b19 P	b18 P	b17 P	b16 -
b31 PF	b30 PF	b29 PF	b28 COSØ	b27 COSØ	b26 COSØ	b25 S	b24 S

Alarms 2

b7 I Harmonics	b6 I Harmonics	b5 THDV	b4 THDV	b3 THDV	b2 F	b1 F	b0 F
b15 -	b14 -	b13 Under Comp.	b12 Over Comp.	b11 Cap. Energy	b10 Ind. Energy	b9 Battery	b8 I Harmonics
b23 -	b22 -	b21 -	b20 -	b19 -	b18 -	b17 -	b16 -
b31 -	b30 -	b29 -	b28 -	b27 -	b26 -	b25 -	b24 -

Abbreviations used for the Alarm Flags are:

Temp. :	Temperature	PF. :	Power Factor
V :	Voltage	F :	Frequency
I :	Current	THDI :	Total Harmonic Distortion in Current
THDV:	Total Harmonic Distortion in Voltage	I Harmonics:	Current Harmonics
V Harmonic Ieri:	Voltage Harmonics	Battery:	Battery Voltage
P:	Active Power	Ind. Energy:	Inductive Energy
Q:	Reactive Power	Cap. Energy:	Capacitive Energy
S:	Apperant Power	Aşırı Komp:	Over Compansation
CosØ :	CosØ	Düşük Komp:	Under Compansation

4.5.2 RAPIDUS Setting Parameters

Operator/programmer should use '10H - Write Multiple Registers and '06H - Write Single Register' to change settings parameters.

Operator/programmer should use '0x3H - Read Holding Registers' function to read setting parameters.

1 register -> comprises of 2 bytes.



After Rapidus setting parameters have been changed, in order for the new values to be saved in non-volatile memory; 0x0000 should be written to register 1998, and 0x0001 should be written in register 1999, within 60 seconds following the last setting change. Only after that, changes will be stored in the permanent memory.

NOTE 1 : 3 parameters given with "RO (Read Only)" in [Table 4-6](#) and [Table 4-8](#) are read-only data.

They cannot be changed by the user. This data is as given below:

- Serial Number
- Firmware Version
- Compiler Version

NOTE 2 : 1998 addressed variable at the end of [Table 4-6](#) and [Table 4-8](#) are a "W (only writable)"

variable.

4.5.2.1 Setting for RAPIDUS 211R-E

Table 4-6 Setting Parameter (Avaliable for RAPIDUS 211R-E)

Address	Parameter	Data Type	Descript.	R/W	Unit	Low Limit	High Limit
Network							
2000	Current Transf. Ratio (CTR)	32 bit float	-	R/W	-	1	5000
2002	Voltage Transf. Ratio (VTR)	32 bit float	-	R/W	-	1	5000
2004	Demand Period	32 bit int.	-	R/W	min.	1	60
2006	Connection	32 bit int.	S15	R/W	-	0	1
Energy							
2008	Start of day	32 bit int.	-	R/W	hour	0	23
2010	Start of month	32 bit int.	-	R/W	-	1	28
2012	kWh	32 bit float	-	R/W	kWh	0	20000000000.0
2014	kWh E.	32 bit float	-	R/W	kWh	0	20000000000.0
2016	kVArh I	32 bit float	-	R/W	kVArh	0	20000000000.0
2018	kVArh C.	32 bit float	-	R/W	kVArh	0	20000000000.0
Step							
2020	Step1 power	32 bit float	-	R/W	kVArh	0	1000
2022	Step1 type	32 bit int.	S1	R/W	-	0	1
2024	Step2 power	32 bit float	-	R/W	kVArh	0	1000
2026	Step2 type	32 bit int.	S1	R/W	-	0	1
2028	Step3 power	32 bit float	-	R/W	kVArh	0	1000
2030	Step3 type	32 bit int.	S1	R/W	-	0	1
2032	Step4 power	32 bit float	-	R/W	kVArh	0	1000
2034	Step4 type	32 bit int.	S1	R/W	-	0	1
2036	Step5 power	32 bit float	-	R/W	kVArh	0	1000
2038	Step5 type	32 bit int.	S1	R/W	-	0	1
2040	Step6 power	32 bit float	-	R/W	kVArh	0	1000
2042	Step6 type	32 bit int.	S1	R/W	-	0	1
2044	Step7 power	32 bit float	-	R/W	kVArh	0	1000
2046	Step7 type	32 bit int.	S1	R/W	-	0	1
2048	Step8 power	32 bit float	-	R/W	kVArh	0	1000
2050	Step8 type	32 bit int.	S1	R/W	-	0	1
2052	Step9 power	32 bit float	-	R/W	kVArh	0	1000
2054	Step9 type	32 bit int.	S1	R/W	-	0	1
2056	Step10 power	32 bit float	-	R/W	kVArh	0	1000
2058	Step10 type	32 bit int.	S1	R/W	-	0	7
2060	Step11 power	32 bit float	-	R/W	kVArh	0	1000
2062	Step11 type	32 bit int.	S1	R/W	-	0	7
2064	Step12 power	32 bit float	-	R/W	kVArh	0	1000

Address	Parameter	Data Type	Descript.	R/W	Unit	Low Limit	High Limit
2066	Step12 type	32 bit int.	S1	R/W	-	0	7
2068	Bank structure	32 bit int.	S2	R/W	-	0	8
2070	Bank power	32 bit float	-	R/W	kVArh	0	1000
2072	Bank count	32 bit int.	-	R/W	-	0	12
2074	Discharge time	32 bit int.	-	R/W	sec	3	1000
Compensation							
2076	Steps	32 bit int.	S3	R/W	-	0	2
2078	Program	32 bit int.	S4	R/W	-	0	4
2080	Target 1	32 bit float	-	R/W	-	-0.800	0.800
2082	Target 2	32 bit float	-	R/W	-	0.000	1.000
2084	Target low limit	32 bit float	-	R/W	-	0.000	0.200
2086	Target 2 high limit	32 bit float	-	R/W	-	0.000	0.200
2088	Activation time	32 bit int.	-	R/W	sec	1	600
2090	Deactivation time	32 bit int.	-	R/W	sec	1	600
2092	Shift angle	32 bit float	-	R/W	-	-45	45
2094	Fixed steps	32 bit int.	S10	R/W	-	0	3
2096	Averaging time	32 bit int.	S14	R/W	-	0	7
Communication							
2098	BaudRate	32 bit int.	S6	R/W	-	0	6
2100	Slaveld	32 bit int.	-	R/W	-	1	247
Alarm							
Voltage Alarm							
2102	Alarm relay	32 bit int.	S5	R/W	-	0	2
2104	Low limit	32 bit float	-	R/W	V	0	1500000
2106	High limit	32 bit float	-	R/W	V	0	1500000
2108	Alarm time	32 bit int.	-	R/W	sec	0	600
2110	Hysteresis	32 bit float	-	R/W	%	0	20
Current Alarm							
2112	Alarm relay	32 bit int.	S5	R/W	-	0	2
2114	Low limit	32 bit float	-	R/W	A	0	30000
2116	High limit	32 bit float	-	R/W	A	0	30000
2118	Alarm time	32 bit int.	-	R/W	sec	0	600
2120	Hysteresis	32 bit float	-	R/W	%	0	20
Active Power Alarm							
2122	Alarm relay	32 bit int.	S5	R/W	-	0	2
2124	Low limit	32 bit float	-	R/W	W	-1,00E+10	1,00E+10
2126	High limit	32 bit float	-	R/W	W	-1,00E+10	1,00E+10
2128	Alarm time	32 bit int.	-	R/W	sec	0	600
2130	Hysteresis	32 bit float	-	R/W	%	0	20
Reactive Power Alarm							
2132	Alarm relay	32 bit int.	S5	R/W	-	0	2
2134	Low limit	32 bit float	-	R/W	VAr	-1,00E+10	1,00E+10
2136	High limit	32 bit float	-	R/W	VAr	-1,00E+10	1,00E+10
2138	Alarm time	32 bit int.	-	R/W	sec	0	600

Address	Parameter	Data Type	Descript.	R/W	Unit	Low Limit	High Limit
2140	Hysteresis	32 bit float	-	R/W	%	0	20
ApperantPower Alarm							
2142	Alarm relay	32 bit int.	S5	R/W	-	0	2
2144	Low limit	32 bit float	-	R/W	A	0	30000
2146	High limit	32 bit float	-	R/W	A	0	30000
2148	Alarm time	32 bit int.	-	R/W	sec	0	600
2150	Hysteresis	32 bit float	-	R/W	%	0	20
Power Factor Alarm							
2152	Alarm relay	32 bit int.	S5	R/W	-	0	2
2154	Low limit	32 bit float	-	R/W	-	0	1
2156	High limit	32 bit float	-	R/W	-	0	1
2158	Alarm time	32 bit int.	-	R/W	sec	0	600
2160	Hysteresis	32 bit float	-	R/W	%	0	20
CosØ Alarm							
2162	Alarm relay	32 bit int.	S5	R/W	-	0	2
2164	Low limit	32 bit float	-	R/W	-	0	1
2166	High limit	32 bit float	-	R/W	-	0	1
2168	Alarm time	32 bit int.	-	R/W	sec	0	600
2170	Hysteresis	32 bit float	-	R/W	%	0	20
Frequency Alarm							
2172	Alarm relay	32 bit int.	S5	R/W	-	0	2
2174	Low limit	32 bit float	-	R/W	Hz	35	70
2176	High limit	32 bit float	-	R/W	Hz	35	70
2178	Alarm time	32 bit int.	-	R/W	sec	0	600
2180	Hysteresis	32 bit float	-	R/W	%	0	20
Temparature Alarm							
2182	Alarm relay	32 bit int.	S5	R/W	-	0	2
2184	Low limit	32 bit float	-	R/W	°C	-20	80
2186	High limit	32 bit float	-	R/W	°C	-20	80
2188	Alarm time	32 bit int.	-	R/W	sec	0	600
2190	Hysteresis	32 bit float	-	R/W	%	0	20
Voltage Harmonics Alarm							
2192	Alarm relay	32 bit int.	S5	R/W	-	0	2
2194	THD_High limit	32 bit float	-	R/W	%	0	100
2196	High limit harmonic 3	32 bit float	-	R/W	%	0	100
2198	High limit harmonic 5	32 bit float	-	R/W	%	0	100
2200	High limit harmonic 7	32 bit float	-	R/W	%	0	100
2202	High limit harmonic 9	32 bit float	-	R/W	%	0	100
2204	High limit harmonic 11	32 bit float	-	R/W	%	0	100
2206	High limit harmonic 13	32 bit float	-	R/W	%	0	100
2208	High limit harmonic 15	32 bit float	-	R/W	%	0	100

Address	Parameter	Data Type	Descript.	R/W	Unit	Low Limit	High Limit
2210	High limit harmonic 17	32 bit float	-	R/W	%	0	100
2212	High limit harmonic 19	32 bit float	-	R/W	%	0	100
2214	High limit harmonic 21	32 bit float	-	R/W	%	0	100
2216	Alarm time	32 bit int.	-	R/W	sn	0	600
CurrentHarmonics Alarm							
2218	Alarm relay	32 bit int.	S5	R/W	%	0	2
2220	THD_High limit	32 bit float	-	R/W	%	0	100
2222	High limit harmonic 3	32 bit float	-	R/W	%	0	100
2224	High limit harmonic 5	32 bit float	-	R/W	%	0	100
2226	High limit harmonic 7	32 bit float	-	R/W	%	0	100
2228	High limit harmonic 9	32 bit float	-	R/W	%	0	100
2230	High limit harmonic 11	32 bit float	-	R/W	%	0	100
2232	High limit harmonic 13	32 bit float	-	R/W	%	0	100
2234	High limit harmonic 15	32 bit float	-	R/W	%	0	100
2236	High limit harmonic 17	32 bit float	-	R/W	%	0	100
2238	High limit harmonic 19	32 bit float	-	R/W	%	0	100
2240	High limit harmonic 21	32 bit float	-	R/W	%	0	100
2242	Alarm time	32 bit int.	-	R/W	sn	0	600
Indüktive Energy(Qind./P) Alarm							
2244	High limit	32 bit float	-	R/W	%	0	40
2246	Alarm relay	32 bit int.	S5	R/W	-	0	2
Capacitive Energy(Qkap./P) Alarm							
2248	High limit	32 bit float	-	R/W	%	0	40
2250	Alarm relay	32 bit int.	S5	R/W	-	0	2
Step Alarm							
2252	Low limit	32 bit float	-	R/W	%	20	100
Mode Input (Day/Night or Generator)							
2254	Mode Input	32 bit int.	S11	R/W	-	0	2
Connection Learn							
2256	Learn conn. at start	32 bit int.	S13	R/W	-	0	1
2258	Learn conn. step number	Learn conn. step number	-	R/W	-	1	12
2260	Learn conn. retry timer	Learn conn. retry timer	-	R/W	sn	5	60
2262	Learn conn. retry count	Learn conn. retry count	-	R/W	-	1	20
Step Learn							
2264	Learn steps at start	32 bit int.	S13	R/W	-	0	1

Address	Parameter	Data Type	Descript.	R/W	Unit	Low Limit	High Limit
Device							
2266	Language	32 bit int.	S7	R/W	-	0	1
2268	Contrast	32 bit int.	S8	R/W	-	0	8
2270	Password	32 bit int.	-	R/W	-	1	9999
2272	Password protection	32 bit int.	S12	R/W	-	1	9999
2274	DisplayOn	32 bit int.	S9	R/W	-	0	1
2276	DisplayTime	32 bit int.	-	R/W	sn	10	600
2278	SerialNumber	32 bit int.	-	RO	-	0	0
2280	FirmwareVer	32 bit float	-	RO	-	0	0
2282	Order Number	32 bit float	-	RO	-	0	0
2284	ConfigName	String	-	R/W	-	0	0
2296	DeviceName	String	-	R/W	-	0	0

Table 4-7 String List (Available for RAPIDUS 211R-E)

SL1	SL2	SL3	SL4	SL5	SL6	SL6
0)C 1)L	0-)1-1-1-1 1-)1-1-2-2 2-)1-2-2-4 3-)1-2-3-3 4-)1-2-4-4 5-)1-1-2-4 6-)1-2-3-4 7-)1-2-4-8 8-)1-1-2-3	0)Entered 1)Predefined 2)DCM	0)Rapidus 1)Asc. Sequential 2)Des. sequential 3)Linear 4)Circular	0)Off 1)Relay1 2)Relay2	0)2400 1)4800 2)9600 3)19200 4)38400 5)57600 6)115200	0)Türkçe 1)English 2)Русский

S8	S9	S10	S11	S12	S13	S14	S15
0-Level -4 1-Level -3 2-Level -2 3-Level -1 4-Level 0 5-Level 1 6-Level 2 7-Level 3 8-Level 4	0) Continuous 1)Time dependent	0)None 1)Stage 1 2)Stage 1 and 2 3)Stage 1, 2 and 3	0)Off 1)Night/Day 2)Generator	0)Inactive 1)Active	0-Off 1-On	0)Off 1)5 sec. 2)10 sec. 3)20 sec. 4)30 sec. 5)40 sec. 6)50 sec. 7)60 sec	0)Phase-Phase 1)Phase - Notr

4.5.2.2 Setting for RAPIDUS 212R

Table 4-8 Settings Parameter(Available for RAPIDUS 212R)

Address	Parameter	Data Type	Descript.	R/W	Unit	Low Limit	High Limit
Network							

Address	Parameter	Data Type	Descript.	R/W	Unit	Low Limit	High Limit
2000	Current Transf. Ratio (CTR)	32 bit float	-	R/W	-	1	5000
2002	Voltage Transf. Ratio (VTR)	32 bit float	-	R/W	-	1	5000
2004	Demand Period	32 bit int.	-	R/W	dk.	1	60
2006	Connection	32 bit int.	S15	R/W	-	0	1
Energy							
2008	Start of day	32 bit int.	-	R/W	hour	0	23
2010	Start of month	32 bit int.	-	R/W	-	1	28
2012	T1 kWh	32 bit float	-	R/W	kWh	0	20000000000.0
2014	T1 kWh E.	32 bit float	-	R/W	kWh	0	20000000000.0
2016	T1 kVArh I.	32 bit float	-	R/W	kVArh	0	20000000000.0
2018	T1 kVArh C.	32 bit float	-	R/W	kVArh	0	20000000000.0
Step							
2020	Step1 power	32 bit float	-	R/W	kVArh	0	1000
2022	Step1 type	32 bit int.	S1	R/W	-	0	1
2024	Step2 power	32 bit float	-	R/W	kVArh	0	1000
2026	Step2 type	32 bit int.	S1	R/W	-	0	1
2028	Step3 power	32 bit float	-	R/W	kVArh	0	1000
2030	Step3 type	32 bit int.	S1	R/W	-	0	1
2032	Step4 power	32 bit float	-	R/W	kVArh	0	1000
2034	Step4 type	32 bit int.	S1	R/W	-	0	1
2036	Step5 power	32 bit float	-	R/W	kVArh	0	1000
2038	Step5 type	32 bit int.	S1	R/W	-	0	1
2040	Step6 power	32 bit float	-	R/W	kVArh	0	1000
2042	Step6 type	32 bit int.	S1	R/W	-	0	1
2044	Step7 power	32 bit float	-	R/W	kVArh	0	1000
2046	Step7 type	32 bit int.	S1	R/W	-	0	1
2048	Step8 power	32 bit float	-	R/W	kVArh	0	1000
2050	Step8 type	32 bit int.	S1	R/W	-	0	1
2052	Step9 power	32 bit float	-	R/W	kVArh	0	1000
2054	Step9 type	32 bit int.	S1	R/W	-	0	1
2056	Step10 power	32 bit float	-	R/W	kVArh	0	1000
2058	Step10 type	32 bit int.	S1	R/W	-	0	1
2060	Step11 power	32 bit float	-	R/W	kVArh	0	1000
2062	Step11 type	32 bit int.	S1	R/W	-	0	1
2064	Step12 power	32 bit float	-	R/W	kVArh	0	1000
2066	Step12 type	32 bit int.	S1	R/W	-	0	1
2068	Step13 power	32 bit float	-	R/W	kVArh	0	1000
2070	Step13 type	32 bit int.	S1	R/W	-	0	1
2072	Step14 power	32 bit float	-	R/W	kVArh	0	1000
2074	Step14 type	32 bit int.	S1	R/W	-	0	1
2076	Step15 power	32 bit float	-	R/W	kVArh	0	1000
2078	Step15 type	32 bit int.	S1	R/W	-	0	1
2080	Step16 power	32 bit float	-	R/W	kVArh	0	1000
2082	Step16 type	32 bit int.	S1	R/W	-	0	1

Address	Parameter	Data Type	Descript.	R/W	Unit	Low Limit	High Limit
2084	Step17 power	32 bit float	-	R/W	kVArh	0	1000
2086	Step17 type	32 bit int.	S1	R/W	-	0	1
2088	Step18 power	32 bit float	-	R/W	kVArh	0	1000
2090	Step18 type	32 bit int.	S1	R/W	-	0	1
2092	Step19 power	32 bit float	-	R/W	kVArh	0	1000
2094	Step19 type	32 bit int.	S1	R/W	-	0	1
2096	Step20 power	32 bit float	-	R/W	kVArh	0	1000
2098	Step20 type	32 bit int.	S1	R/W	-	0	1
2100	Step21 power	32 bit float	-	R/W	kVArh	0	1000
2102	Step21 type	32 bit int.	S1	R/W	-	0	1
2104	Step22 power	32 bit float	-	R/W	kVArh	0	1000
2106	Step22 type	32 bit int.	S1	R/W	-	0	1
2108	Step23 power	32 bit float	-	R/W	kVArh	0	1000
2110	Step23 type	32 bit int.	S1	R/W	-	0	1
2112	Step24 power	32 bit float	-	R/W	kVArh	0	1000
2114	Step24 type	32 bit int.	S1	R/W	-	0	1
2118	Bank power	32 bit float	-	R/W	kVArh	0	1000
2120	Bank count	32 bit int.	-	R/W	-	0	24
2122	Discharge time	32 bit int.	-	R/W	sec	3	1000
Compensation							
2124	Steps	32 bit int.	S3	R/W	-	0	1
2126	Program	32 bit int.	S4	R/W	-	0	4
2128	Target 1	32 bit float	-	R/W	-	-0.800	0.800
2130	Target 2	32 bit float	-	R/W	-	0.000	1.000
2132	Target low limit	32 bit float	-	R/W	-	0.000	0.200
2134	Target high limit	32 bit float	-	R/W	-	0.000	0.200
2136	Activation time	32 bit int.	-	R/W	sec	1	600
2138	Deactivation time	32 bit int.	-	R/W	sec	1	600
2140	Shift angle	32 bit float	-	R/W	-	-45	45
2142	Fixed steps	32 bit int.	S10	R/W	-	0	3
2144	Averaging time	32 bit int.	S14	R/W	-	0	7
Communication							
2146	BaudRate	32 bit int.	S6	R/W	-	0	6
2148	Slaveld	32 bit int.	-	R/W	-	1	247
Alarm							
Voltage Alarm							
2150	Alarm relay	32 bit int.	S5	R/W	-	0	2
2152	Low limit	32 bit float	-	R/W	V	0	1500000
2154	High limit	32 bit float	-	R/W	V	0	1500000
2156	Alarm time	32 bit int.	-	R/W	sn	0	600
2158	Hysteresis	32 bit float	-	R/W	%	0	20
CURRENT ALARM							
2160	Alarm relay	32 bit int.	S5	R/W	-	0	2
2162	Low limit	32 bit float	-	R/W	A	0	30000

Address	Parameter	Data Type	Descript.	R/W	Unit	Low Limit	High Limit
2164	High limit	32 bit float	-	R/W	A	0	30000
2166	Alarm time	32 bit int.	-	R/W	sn	0	600
2168	Hysteresis	32 bit float	-	R/W	%	0	20
ACTIVE POWER ALARM							
2170	Alarm relay	32 bit int.	S5	R/W	-	0	2
2172	Low limit	32 bit float	-	R/W	W	-1,00E+10	1,00E+10
2174	High limit	32 bit float	-	R/W	W	-1,00E+10	1,00E+10
2176	Alarm time	32 bit int.	-	R/W	sn	0	600
2178	Hysteresis	32 bit float	-	R/W	%	0	20
REACTIVE POWER ALARM							
2180	Alarm relay	32 bit int.	S5	R/W	-	0	2
2182	Low limit	32 bit float	-	R/W	VAr	-1,00E+10	1,00E+10
2184	High limit	32 bit float	-	R/W	VAr	-1,00E+10	1,00E+10
2186	Alarm time	32 bit int.	-	R/W	sn	0	600
2188	Hysteresis	32 bit float	-	R/W	%	0	20
APPARENT POWER ALARM							
2190	Alarm relay	32 bit int.	S5	R/W	-	0	2
2192	Low limit	32 bit float	-	R/W	A	0	30000
2194	High limit	32 bit float	-	R/W	A	0	30000
2196	Alarm time	32 bit int.	-	R/W	sn	0	600
2198	Hysteresis	32 bit float	-	R/W	%	0	20
POWER FACTOR ALARM							
2200	Alarm relay	32 bit int.	S5	R/W	-	0	2
2202	Low limit	32 bit float	-	R/W	-	0	1
2204	High limit	32 bit float	-	R/W	-	0	1
2206	Alarm time	32 bit int.	-	R/W	sn	0	600
2208	Hysteresis	32 bit float	-	R/W	%	0	20
COSØ ALARM							
2210	Alarm relay	32 bit int.	S5	R/W	-	0	2
2212	Low limit	32 bit float	-	R/W	-	0	1
2214	High limit	32 bit float	-	R/W	-	0	1
2216	Alarm time	32 bit int.	-	R/W	sn	0	600
2218	Hysteresis	32 bit float	-	R/W	%	0	20
FREQUENCY ALARM							
2220	Alarm relay	32 bit int.	S5	R/W	-	0	2
2222	Low limit	32 bit float	-	R/W	Hz	35	70
2224	High limit	32 bit float	-	R/W	Hz	35	70
2226	Alarm time	32 bit int.	-	R/W	sn	0	600
2228	Hysteresis	32 bit float	-	R/W	%	0	20
TEMPERATURE ALARM							
2230	Alarm relay	32 bit int.	S5	R/W	-	0	2
2232	Low limit	32 bit float	-	R/W	°C	-20	80
2234	High limit	32 bit float	-	R/W	°C	-20	80
2236	Alarm time	32 bit int.	-	R/W	sn	0	600

Address	Parameter	Data Type	Descript.	R/W	Unit	Low Limit	High Limit
2238	Hysteresis	32 bit float	-	R/W	%	0	20
VOLTAGE HARMONICS ALARM							
2240	Alarm relay	32 bit int.	S5	R/W	-	0	2
2242	THD_High limit	32 bit float	-	R/W	%	0	100
2244	High limit harmonic 3	32 bit float	-	R/W	%	0	100
2246	High limit harmonic 5	32 bit float	-	R/W	%	0	100
2248	High limit harmonic 7	32 bit float	-	R/W	%	0	100
2250	High limit harmonic 9	32 bit float	-	R/W	%	0	100
2252	High limit harmonic 11	32 bit float	-	R/W	%	0	100
2254	High limit harmonic 13	32 bit float	-	R/W	%	0	100
2256	High limit harmonic 15	32 bit float	-	R/W	%	0	100
2258	High limit harmonic 17	32 bit float	-	R/W	%	0	100
2260	High limit harmonic 19	32 bit float	-	R/W	%	0	100
2262	High limit harmonic 21	32 bit float	-	R/W	%	0	100
2264	Alarm time	32 bit int.	-	R/W	sn	0	600
CURRENT HARMONICS ALARM							
2266	Alarm relay	32 bit int.	S5	R/W	%	0	2
2268	THD_High limit	32 bit float	-	R/W	%	0	100
2270	High limit harmonic 3	32 bit float	-	R/W	%	0	100
2272	High limit harmonic 5	32 bit float	-	R/W	%	0	100
2274	High limit harmonic 7	32 bit float	-	R/W	%	0	100
2276	High limit harmonic 9	32 bit float	-	R/W	%	0	100
2278	High limit harmonic 11	32 bit float	-	R/W	%	0	100
2280	High limit harmonic 13	32 bit float	-	R/W	%	0	100
2282	High limit harmonic 15	32 bit float	-	R/W	%	0	100
2284	High limit harmonic 17	32 bit float	-	R/W	%	0	100
2286	High limit harmonic 19	32 bit float	-	R/W	%	0	100
2288	High limit harmonic 21	32 bit float	-	R/W	%	0	100
2290	Alarm time	32 bit int.	-	R/W	sn	0	600
INDUCTIVE ENERGY ALARM (Qind./P)							
2292	High limit	32 bit float	-	R/W	%	0	40
2294	Alarm relay	32 bit int.	S5	R/W	-	0	2
Capacitive Energy Alarm (Qkap./P)							
2296	High limit	32 bit float	-	R/W	%	0	40
2298	Alarm relay	32 bit int.	S5	R/W	-	0	2
MODE INPUT (DAY/NIGHT or GENERATOR)							
2300	Mode Input	32 bit float	S11	R/W	-	0	2
CONNECTION LEARN							
2302	Learn conn. at start	32 bit int.	S13	R/W	-	0	1
2304	Learn conn. step number	32 bit int.	-	R/W	-	1	12
2306	Learn conn. retry timer	32 bit int.	-	R/W	sn	5	60
2308	Learn conn. retry count	32 bit int.	-	R/W	-	1	20
STEP LEARN							
2310	Learn steps at start	32 bit int.	S13	R/W	-	0	1



Address	Parameter	Data Type	Descript.	R/W	Unit	Low Limit	High Limit
DEVICE							
2312	Language	32 bit int.	S7	R/W	-	0	1
2314	Contrast	32 bit int.	S8	R/W	-	0	8
2316	Password	32 bit int.	-	R/W	-	1	9999
2318	Password protection	32 bit int.	S12	R/W	-	0	1
2320	DisplayOn	32 bit int.	S9	R/W	-	0	1
2322	DisplayTime	32 bit int.	-	R/W	sn	10	600
2324	SerialNumber	32 bit int.	-	RO	-	0	0
2326	FirmwareVer	32 bit float	-	RO	-	0	0
2328	Order Number	32 bit float	-	RO	-	0	0
2330	ConfigName	String	-	R/W	-	0	0
2342	DeviceName	String	-	R/W	-	0	0

Table 4-9 String List (Avaliable for RAPIDUS 212R-E)

SL1	SL2	SL3	SL4	SL5	SL6	SL6
0)C 1)L	0-)1 - 1 - 1 - 1 1-)1 - 1 - 2 - 2 2-)1 - 2 - 2 - 4 3-)1 - 2 - 3 - 3 4-)1 - 2 - 4 - 4 5-)1 - 1 - 2 - 4 6-)1 - 2 - 3 - 4 7-)1 - 2 - 4 - 8 8-)1 - 1 - 2 - 3	0-Entered 1-Predefined	0-Rapidus 1-Asc. Sequential 2-Des. sequential 3-Linear 4-Circular	0-Off 1-Relay1 2-Relay2	0)2400 1)4800 2)9600 3)19200 4)38400 5)57600 6)115200	0)Türkçe 1)English 2)Русский



S8	S9	S10	S11	S12	S13	S14	S14
0-Level -4	0-Continuous	0-None	0)Inactive	0)Inactive	0-Off	0)Off	1)Phase-Phase
1-Level -3	1-Time	1-Stage 1	1)Active	1)Active	1-On	1)5 sec.	2)Phase - Notr
2-Level -2	dependent	2-Stage 1				2)10 sec.	
3-Level -1		and 2				3)20 sec.	
4-Level 0		3-Stage 1, 2				4)30 sec.	
5-Level 1		and 3				5)40 sec.	
6-Level 2						6)50 sec.	
7-Level 3						7)60 sec	
8-Level 4							

EXAMPLE:

If slave ID is assigned as 157;

Request		RAPIDUS Response	
Slave ID	01h	Slave ID	01h
Function code	10h	Function code	10h
Starting address (high)	08h	Starting address (high)	08h
Starting address (low)	26h	Starting address (low)	26h
Number of registers (high)	00h	Number of registers (high)	00h
Number of registers (low)	02h	Number of registers (low)	02h
Number of bytes	04h	CRC (high)	A2h
Register value (high)	00h	CRC (low)	63h
Register value (low)	00h		
Register value (high)	00h		
Register value (low)	9Dh		
CRC (high)	D7h		
CRC (low)	F4h		

4.5.3 ARCHIVE (HISTORY) RECORDS

RAPIDUS archive records consist of blocks having 68 parameters. Each parameter inside the archive block is a 32 bit length variable. Archive data block is as shown in Table 4-10.

The programmer will access archive by implementing “0x14 - Read File Record” function. “0x14 - Read File Record” function accesses the data with “file numbers”.

For RAPIDUS,

File numbers 1 – 1920 are used to access HOURLY data. File numbers 5001- 5240 are used to access DAILY data.

File numbers 10001-10036 are used to access MONTHLY data.

- The last saved file number in the hourly data memory for RAPIDUS 211R-E; can be accessed from 660 modbus addressed parameter (Refer to Table 4-4).
- The last saved file number in the hourly data memory for RAPIDUS 212R-E; can be

accessed from 708 modbus addressed parameter (Refer to Table 4-5).

- The last saved file number in the daily data memory for RAPIDUS 211R-E; can be accessed from 662 modbus addressed parameter (Refer to Table 4-4).
- The last saved file number in the daily data memory for RAPIDUS 212R-E; can be accessed from 710 modbus addressed parameter (Refer to Table 4-5).
- The last saved file number in the mothly data memory for RAPIDUS 211R-E; can be accessed from 664 modbus addressed parameter (Refer to Table 4-4).
- The last saved file number in the montly data memory for RAPIDUS 212R-E; can be accessed from 712 modbus addressed parameter (Refer to Table 4-5).

Table 4-10 Archive (History) Record Table

Item No.	History Records	Variable Type
1	Time Info (Timestamp)	32 bit int.
2	Average voltage value (V ave.)	32 bit float
3	Minimum voltage value (V min.)	32 bit float
4	Maximum voltage value (V max.)	32 bit float
5	Average current value (I ave.)	32 bit float
6	Minimum current value (I min.)	32 bit float
7	Maximum current value (I max.)	32 bit float
8	Average active power value (P ave.)	32 bit float
9	Minimum active power value (P min.)	32 bit float
10	Maximum active power value (P max.)	32 bit float
11	Average reactive power value (Q ave.)	32 bit float
12	Minimum reactive power value (Q min.)	32 bit float
13	Maximum reactive power value (Q max.)	32 bit float
14	Average apparent power value (S ave.)	32 bit float
15	Minimum apparent power value (S min.)	32 bit float
16	Maximum apparent power value (S max.)	32 bit float
17	Average cosØ value (cosØ ave.)	32 bit float
18	Average PF value (PF ave.)	32 bit float
19	average frequency value (F ave.)	32 bit float
20	L2 minimum voltage value(V2 min.)	32 bit float
20	Minimum frequency value (F min.)	32 bit float
21	Maximum frequency value (F max.)	32 bit float
22	Consumed-imp. active energy value (T1 kWh)	32 bit float
23	Generated-exp. active energy value (T1 kWh E.)	32 bit float
24	Inductive reactive energy value (T1 kWh I.)	32 bit float
25	Capacitive reactive energy value (T1 kWh C.)	32 bit float



4.5.3.1 Hourly archive data

The smallest and largest instantaneous values measured during one hour period, are saved as minimum and maximum values. Likewise, average values of measurements, which were taken in one hour period, are saved as average values.

14h function operates with file numbers. File numbers between 1 – 1920 are used for HOURLY data.

Rapidus has a memory that is reserved for hourly files. It can keep totally 1920 hourly files.

Assume that, reserved memory for hourly files are filled completely. In this case, the last saved file number will be “1920” and user can access this number with querying 660th modbus address for RAPIDUS 211R-E (Refer to table 4-4). and 708th modbus address for RAPIDUS 212R-E (Refer to table 4-5).

1st file memory=> Hourly Data Record-1
2nd file memory=> Hourly Data Record-2
3rd file memory=> Hourly Data Record-3
.
.
.
19th file memory=> Hourly Data Record-1919
20th file memory=> Hourly Data Record-1920

If there is not enough memory for one more hourly data, the oldest record is deleted and the latest record is saved to first file memory. In this case, the last saved file number will be “1”.

1st file memory=> Hourly Data Record-1921
2nd file memory=> Hourly Data Record-2
3rd file memory=> Hourly Data Record-3
.
.
.
19th file memory=> Hourly Data Record-1919
20th file memory=> Hourly Data Record-1920

When one more hourly record is come, the last saved file number will be “2”.
Example of upper case;

1st file memory=> Hourly Data Record-1921
2nd file memory=> Hourly Data Record-1922
3rd file memory=> Hourly Data Record-3
.
.



.
19th file memory=> Hourly Data Record-1919
20th file memory=> Hourly Data Record-1920

Briefly, when hourly memory of Rapidus is filled completely, oldest record is deleted and new record is saved in the deleted record's memory.

The 'last saved file number' inside the hourly memory can be accessed from the 32-bit parameter starting from Modbus address 660 (RAPIDUS 211R) (Refer to table 4-4) or Modbus address 708 (RAPIDUS 212R) (Refer to table 4-5).

EXAMPLE:

Assume that a programmer will try to access a RAPIDUS with a slave ID number 1. Assume also that the last saved hourly file number of this device is 17. In this case, data request and RAPIDUS response will be as follows:

Query	
Slave ID	0x01
Function code	0x14
Byte Counts	0x07
Sub-req. 1 reference type	0x06
Sub-req. 1 file number HI	0x00
Sub-req. 1 file number LO	0x11
Sub-req. 1 starting reg. addr. HI	0x00
Sub-req. 1 starting reg. addr. LO	0x00
Sub-req. 1 register count HI	0x00
Sub-req. 1 register count LO	0x0A
CRC HI	0xB3
CRC LO	0xD4

Rapidus Response	
Slave ID	0x01
Function code	0x14
Byte count	0x16
Sub-req. 1 byte count	0x15
Sub-req. 1 reference type	0x06
Timestamp	XXX
Timestamp	XXX
Timestamp	XXX
Timestamp	XXX

CRC HI	XXX
CRC LO	XXX

The parameters and CRC values in above tables, are as they should be. On the other hand, Rapidus response is given to describe the message structure. As a result, values for variables are not defined.

4.5.3.2 Daily archive data

Recording of daily data changes with start of day (Refer to 3.2.1.2.6.1) setting.

The smallest and largest instantaneous values measured during one day period, are saved as minimum and maximum values. Likewise, average values of measurements, which were taken in one day period, are saved as average values.

14h function operates with file numbers. File numbers 5001 – 5240 are used for DAILY data.

Rapidus has a memory that is reserved for daily files. It can keep totally 240 daily files. When daily memory of Rapidus is filled completely, oldest record is deleted and new record is saved in the deleted record's memory. For more information about record structure of Rapidus, please look at [4.5.3.1 Hourly archive data](#).

The 'last saved file number' inside the daily memory can be accessed from the 32-bit parameter starting from Modbus address 662 for RAPIDUS 211R-E ([Refer to table 4-4](#)) and Modbus address 710 for RAPIDUS 212R-E ([Refer to Table 4-5](#))

4.5.3.3 Monthly archive data

Recording of daily data changes with start of month ([Refer to 3.2.1.2.6.2](#)) and start of day ([Refer to 3.2.1.2.6.1](#)) settings.

The smallest and largest instantaneous values measured during one month period, are saved as minimum and maximum values. Likewise, average values of measurements, which were taken in one month period, are saved as average values.

14h function operates with file numbers. File numbers 10001 – 10036 are used for MONTHLY data.

Rapidus has a memory that is reserved for monthly files. It can keep totally 36 monthly files.

When monthly memory of Rapidus is filled completely, oldest record is deleted and new record is saved in the deleted record's memory. For more information about record structure of Rapidus, please look at [4.5.3.1 Hourly archive data](#).

The 'last saved file number' inside the daily memory can be accessed from the 32-bit parameter starting from Modbus address 664 for RAPIDUS 211R-E ([Refer to table 4-4](#)) and Modbus address 714 for RAPIDUS 212R-E ([Refer to Table 4-5](#))

4.5.4 Clear

Operator/programmer can erase/zeroize data stored in non-volatile memory via MODBUS commands. Erasable data are as follows:

- energy meters (all Tariff 1 and Tariff 2 meters)
- demand values
- all digital input counters
- all variables mentioned above
- hourly archive records
- daily archive records

monthly archive records
alarm records

Table 4-11 Clear Address Table

Address	Data Type	Parameters/Records to be Cleared	R/W	Value	Modbus func.
1900	32 bit int.	Energy meters	W	1	10H-06H
1902	32 bit int.	Demand values	W	1	10H-06H
1904	32 bit int.	Digital input counters	W	1	10H-06H
1906	32 bit int.	All variables above	W	1	10H-06H
1910	32 bit int.	Hourly archive records	W	1	10H-06H
1912	32 bit int.	Daily archive records	W	1	10H-06H
1914	32 bit int.	Monthly archive records	W	1	10H-06H
1916	32 bit int.	Alarm records	W	1	10H-06H
In order to complete to erase/zeroize, programmer should write 1 to the below MODBUS address:					
1898	32 bit int.	Complete erasing/zeroizing	W	1	10H-06H



In order to complete clearing process, operator/programmer should:
- Write "1" to registers related with 'to be cleared parameters'- Then, write 0 to 1898 register, and 1 to 1899 register, "within 6"



RAPIDUS

Power Factor
Controller

**SECTION 5
FACTORY
PRESETS**



SECTION 5 FACTORY PRESETS

	Factory Presets	Unit	Setting Values
Network Settings			
CTR	1	-	1 5000
VTR	1	-	1.0 5000.0
Demand Period	15	min	1 60
Step Settings			
Ent. Power	10	kVar	0.00↔1000.00
Ent. Type	C	-	C, L,
Predefined Structure	1-1-1-1	-	1-1-1-1, 1-1-2-2, 1-2-2-4, 1-2-3-3, 1-2-4-4, 1-1-2-4, 1-2-3-4, 1-2-4-8, 1-1-2-3
Predefined Power	10	kVar	0.00↔1000.00
Number of Predefined Steps	12	-	1↔12 / 1↔24
Discharge Time	15	s	3↔1000
Compensation Settings			
Steps	Entered	-	Entered, Predefined
Program	Rapidus	-	Rapidus, Ascending Sequential, Descending Sequential, Linear, Circular, Manual
Target 1	1.000	-	-0.800↔0.800
Target 2	0.900	-	0.800↔1.000
Target low limit	0.002	-	0.000↔0.200
Target high limit	0.002	-	0.000↔0.200
Activation Time	10	s	1↔500
Deactivation Time	10	s	1↔500
Shift Angle	0.00	°	-45.00 °↔45.00 °
Averaging Time	Off	s	Off, 5 s, 10 s, 20 s, 30 s, 40 s, 50 s, 60 s
Fixed Steps	N/A	-	N/A, Step 1, Step 1 and 2, Step 1,2 and 3
Learn Settings			

	Factory Presets	Unit	Setting Values
Connection	Off	-	Off, On
Step number	1	-	1↔12 / 1↔24
Retry Time	5	min	5↔60
Retry Number	3	-	1↔20
Learn Step	Off	-	Off, On
Aux. Input Settings			
Mode	Off	-	Off, Night/Day, Generator
Device Settings			
Language	English	-	English, Türkçe, Русский
Contrast	Level 0	-	Level 4↔Level -4
Pass. Protection	On	-	Off, On
New Password	1	-	1↔9999
Display On	Time Dependent	-	Time Dependent, Continuous
Display On Time	600	s	10↔600
Energy Settings			
Start of Day	0	h	0↔23
Start of Month	1		1↔28
kWh	1000000.000	kWh	0.0↔20000000000.0
kWh E.	1000000.000	kWh	0.0↔20000000000.0
kVArh I.	1000000.000	kVArh	0.0↔20000000000.0
kVArh C.	1000000.000	kVArh	0.0↔20000000000.0
Communication Settings			
Baud Rate	38400	bps	2400, 4800, 9600, 19200, 38400, 57600
Slave Id	1	-	1↔247
Alarm Settings			
Energy			
Inductive Hi Limit	20.0	%	0.0↔40.0
Alarm Relay	Off	-	Off, Relay1, Relay2
Capacitive Hi Limit	15.0	%	0.0↔40.0
Alarm Relay	Off	-	Off, Relay1, Relay2

V

	Factory Presets	Unit	Setting Values
Alarm Relay	Off	-	Off, Relay1, Relay2
Low Limit	0.0	V	0.0↔1500000
High Limit	0.0	V	0.0↔1500000
Delay	0	s	0↔600
Hysteresis	0.0	%	0.0↔20
Current			
Alarm Relay	Off	-	Off, Relay1, Relay2
Low Limit	0.0	A	0.0↔30000.0
High Limit	0.0	A	0.0↔30000.0
Delay	0	s	0↔600
Hysteresis	0.0	%	0.0↔20
P			
Alarm Relay	Off	-	Off, Relay1, Relay2
Low Limit	0.0	W	-1000000000.0↔10000000000.0
High Limit	0.0	W	-1000000000.0↔10000000000.0
Delay	0	s	0↔600
Hysteresis	0.0	%	0.0↔20
Q			
Alarm Relay	Off	-	Off, Relay1, Relay2
Low Limit	0.0	VAr	-1000000000.0↔10000000000.0
High Limit	0.0	VAr	-1000000000.0↔10000000000.0
Delay	0	s	0↔600
Hysteresis	0.0	%	0.0↔20
S			
Alarm Relay	Off	-	Off, Relay1, Relay2
Low Limit	0.0	VA	0.0↔10000000000.0
High Limit	0.0	VA	0.0↔10000000000.0
Delay	0	s	0↔600
Hysteresis	0.0	%	0.0↔20
CosØ, PF			
Alarm Relay	Off	-	Off, Relay1, Relay2
Low Limit	0.000	-	0.000↔1.000
High Limit	0.000	-	0.000↔1.000
Delay	0	s	0↔600
Hysteresis	0.0	%	0.0↔20
Step			

	Factory Presets	Unit	Setting Values
Low Limit	20.0	-	20.0↔100.0
F			
Alarm Relay	Off	-	Off, Relay1, Relay2
Low Limit	50.0	Hz	45.0↔65.0
High Limit	50.0	Hz	45.0↔65.0
Delay	0	s	0↔600
Hysteresis	0.0	%	0.0↔20
Harmonics V			
Alarm Relay	Off	-	Off, Relay1, Relay2
THDV Hi Limit	0.0	%	0.0↔100.0
V3 Hi Limit	0.0	%	0.0↔100.0
V5 Hi Limit	0.0	%	0.0↔100.0
V7 Hi Limit	0.0	%	0.0↔100.0
V9 Hi Limit	0.0	%	0.0↔100.0
V11 Hi Limit	0.0	%	0.0↔100.0
V13 Hi Limit	0.0	%	0.0↔100.0
V15 Hi Limit	0.0	%	0.0↔100.0
V17 Hi Limit	0.0	%	0.0↔100.0
V19 Hi Limit	0.0	%	0.0↔100.0
V21 Hi Limit	0.0	%	0.0↔100.0
Harmonics I			
Alarm Relay	Off	-	Off, Relay1, Relay2
THDI Hi Limit	0.0	%	0.0↔100.0
I3 Hi Limit	0.0	%	0.0↔100.0
I5 Hi Limit	0.0	%	0.0↔100.0
I7 Hi Limit	0.0	%	0.0↔100.0
I9 Hi Limit	0.0	%	0.0↔100.0
I11 Hi Limit	0.0	%	0.0↔100.0
I13 Hi Limit	0.0	%	0.0↔100.0
I15 Hi Limit	0.0	%	0.0↔100.0
I17 Hi Limit	0.0	%	0.0↔100.0
I19 Hi Limit	0.0	%	0.0↔100.0
I21 Hi Limit	0.0	%	0.0↔100.0
Temperature			
Alarm Relay	Off	-	Off, Relay1, Relay2
Low Limit	0.0	°C	-20.0 °C ↔55 °C
High Limit	0.0	°C	-20.0 °C ↔55 °C
Delay	0	s	0↔600
Hysteresis	0.0	%	0.0↔20.0



RAPIDUS

Power Factor
Controller

**SECTION 6
TECHNICAL
SPECIFICATIONS**



SECTION 6 TECHNICAL SPECIFICATIONS

Supply

Voltage.....95..410V AC ± 10%
Frequency.....45..65 Hz

Measurement Inputs

Voltage..... 95..410V AC ± 10% (L-N)
95..410V AC ± 10% (L-L)
Current..... 10mA..6A AC
Frequency..... 45..65 Hz
Night/Day Input.....95..240V AC

Measurement Accuracy

Function Symbol	Function	Function Performance Class According to IEC 61557-12	Measuring Range	Other Complementary Characteristics
P	Total active power	0,2	1 % $I_n \leq I \leq I_{max}$ 0,5 Ind to 0,8 Cap	-
Q_V	Total reactive power	1	2 % $I_n \leq I \leq I_{max}$ 0,25 Ind to 0,25 Cap	-
S_A	Total apparent power	0,2	2 % $I_n \leq I \leq I_{max}$	-
E_A	Total active energy	0,2	0 to 49999999999	IEC 62053-22 Class 0.2S
E_{rV}	Total reactive energy	2	0 to 49999999999	IEC 62053-23 Class 2
f	Frequency	0,05	45 – 65 Hz	-
I	Phase current	0,2	10 % $I_n \leq I \leq I_{max}$	-
I_{Nc}	Neutral current (calculated)	0,5	10 % $I_n \leq I \leq I_{max}$	-
U	Voltage	0,2	$U_{min} \leq U \leq U_{max}$	-
PF_A	Power factor	0,5	0,5 Ind to 0,8 Cap	-
THDV	Total harmonic distortion voltage	1	0 % to 20 %	-
THDI	Total harmonic distortion current	1	0 % to 100 %	-

Relay Outputs for Compensation

12/24 pcs.,

Max. switching voltage : 250 VAC

Max. switchig current..... : 1.5 A (all relays active)

5.0 A (only one relay is activated)

Alarm Relay Outputs:

2 pcs,

Max. switching current.....: 4A

Max. switching voltage: 250 VAC

Max. switching power..... : 1250 VA

Number of Steps

Can be selected between 1-12/1-24.

Target Cos ϕ Interval

-0.800-0.800 can be selected with 0.001 steps.

CTR

Can be set 1..5000.

VTR

Can be set 1..5000.

Demand Period

Can be set 1 to 60 minutes.

User Interface

Keypad: 6 keys with ESD protection

LCD: Self-illuminated 160 x 240 graphic

Communication

Isolated RS485 Port.....:1 Channel, ESD and over current/voltage protected,
programmable, 2400bps to 57600 bps baud rate.
2000VRMS isolation.

Operating Temperature

-20°C..+55°C

Storage Temperature

-30°C..+80°C

Relative Humidity

Maximum 95% No Condensation

Dimensions

W144 x H144 x D78

Protection class

Front panel : IP40

Rear cover : IP20

Power Consumption

<10VA

